

BUILDINGS AS MATERIAL BANKS

TESTING BAMB RESULTS THROUGH PROTOTYPING AND PILOT PROJECTS

D14 – 4 pilots built + Feedback report

28.02.2019

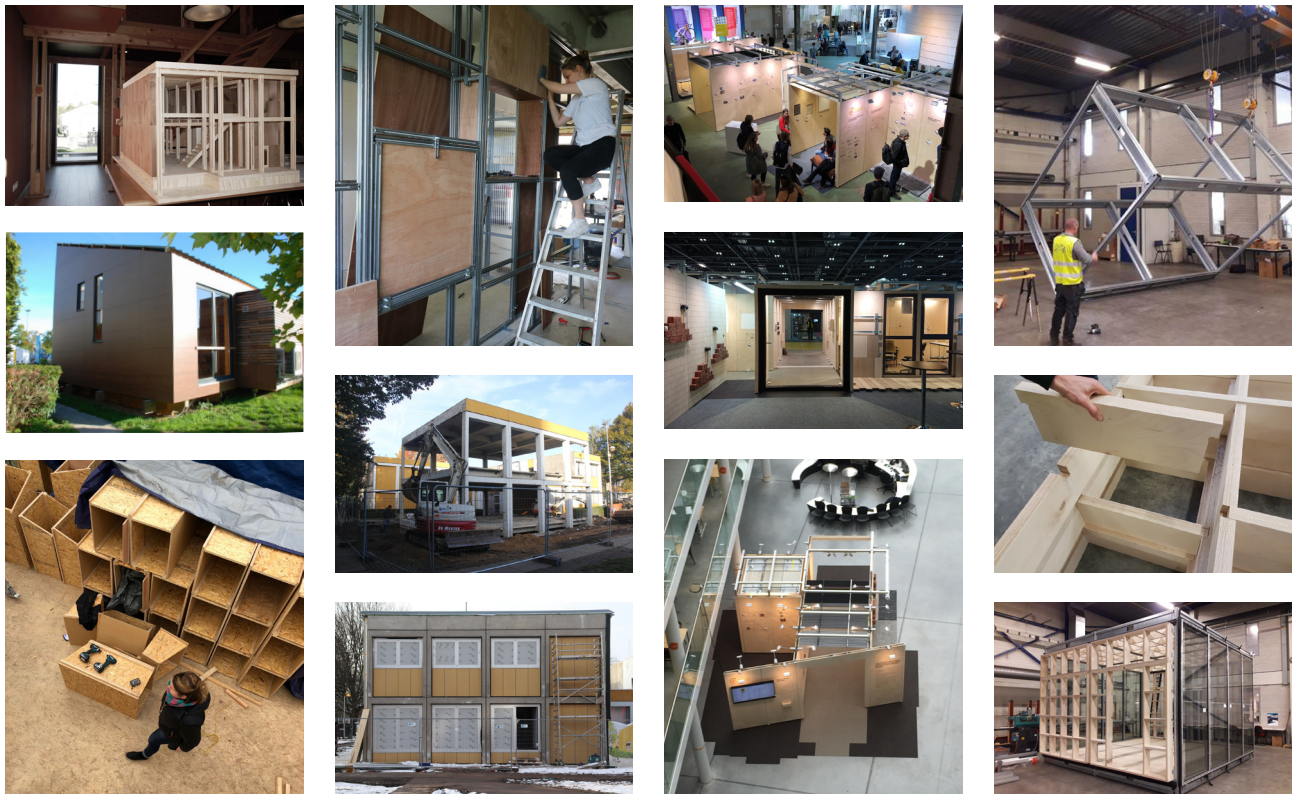

AUTHORS OF THE REPORT

Brussels Environment

Coordinator and co-author of the report

Teodora Capelle

CONTRIBUTORS

Stephanie Mantell

REVIEWERS:

Molly Steinlage

Caroline Henrotay

CO-AUTHORS:

BRE

Building Research Establishment

LCA study on the BRIC project

Mirko Farnetani

Flavie Lowres

Kiruthiga Balson

PARTNERS, CO-AUTHORS AND AUTHORS OF INDIVIDUAL REPORTS

Universiteit Twente/Sarajevo Green Design Foundation

Elma Durmisevic

VUB Vrije Universiteit Brussel

Stijn Brancart

Anne Paduart

Stijn Elsen

Wesley Lankriet

Jeroen Poppe

EPEA Nederland B.V.

Ernst-Jan Mul

Lars Luscuere

EFP Centre de formation KARBON Architecture et urbanisme

Caroline Morizur

Matthieu Delatte

CO-AUTHORS D13

LCA , LCC studies on the GTB and CRL project

Wim Debacker

REVIEWERS

TUM Technische Universität München

Matthias Heinrich

ACRONYMS AND ABBREVIATIONS USED

Pilot Projects

List of project beneficiaries
(complete and shortened names)

BE	Brussels Environment
BRE	Building Research Establishment
EPEA	EPEA Nederland B.V.
VITO	Vlaamse Instelling Voor Technologisch Onderzoek N.V.
VUB	Vrije Universiteit Brussel
TUM	Technische Universität München
UTwente	Universiteit Twente
SGDF	Sarajevo Green Design Foundation

Pilot Projects

GTB Lab	Green Transformable Building Lab
REM	Reversible Experience Modules
CRL	Circular Retrofit Lab
BRIC	Build Reversible in Conception

Acronyms

BAMB	Buildings As Material Banks
BIM	Building Information Modelling
D	Deliverable
LCA	Life Cycle Assessment
LCCA	Life Cycle Costing Analysis
MP	Material Passport
MPP	Materials Passports Platform
PCT	Project Coordination Team
SN	Stakeholder Network
WP	Work Package
WP1	Developing a blueprint for dynamic and circular buildings and materials upcycling
WP2	Developing Materials Passports and corresponding database & platform
WP3	Developing Reversible Building Design tools for dynamic and circular buildings
WP4	Testing BAMB results through prototyping and pilot projects
WP5	Facilitating future applications and exploitation of BAMB results





BUILDINGS AS MATERIAL BANKS

Within the BAMB Project – **Buildings as Material Banks** – 15 partners from 7 European countries have worked together with one mission: enabling **a systemic shift in the building sector** by creating circular solutions.

Today, building materials end up as waste when no longer needed, with effects like destroying eco-systems, increasing environmental costs, and creating risks of resource scarcity. To create a sustainable future, the building sector needs to move **towards a circular economy**.

Whether an industry goes circular or not depends on the value of the materials used – worthless materials are waste, while valuable materials are recycled. Increased value equals less waste, and that is what **BAMB is creating – ways to use and maintain the value of building materials and construction systems over time**.

BAMB contributes to a systemic shift where dynamically and flexibly designed buildings can be incorporated into a circular economy. **Through circular design and value chains, materials in buildings sustain their value**. Instead of being to-be waste, buildings will function as banks of valuable materials – slowing down the usage of resources to a rate that meets the capacity of the planet and producing less waste.



CONTENTS

1. BUILDINGS AS MATERIAL BANKS	
1.1. A SYSTEMIC APPROACH	8
1.2. PILOT PROJECTS	8
1.3. LABORATORY OF CIRCULAR KNOWLEDGE	9
2. REPORT SUMMARY	
2.1. TESTING BAMB RESULTS THROUGH PROTOTYPING AND PILOTS	10
2.2. PILOTS BUILT AND FEEDBACK REPORT	11
3. GENERAL PRESENTATION OF PILOT PROJECTS	
3.1. BUILD REVERSIBLE IN CONCEPTION (BRIC)	16
3.2. GREEN TRANSFORMABLE BUILDING LAB (GTB LAB)	18
3.3. REVERSIBLE EXPERIENCE MODULES (REMs)	20
3.4. CIRCULAR RETROFIT LAB (CRL)	22
4. ASSESSMENT OF CONSTRUCTION, DISASSEMBLY, TRANSFORMATION AND RELOCATION	
4.1. GENERAL CONTEXT	26
4.2. BUILDING ENVIRONMENT - THE DNA OF SUSTAINABLE DEVELOPMENT	27
4.3. REVERSIBLE BUILDING DESIGN	28
BUILDING RECONFIGURATION	28
SPATIAL REVERSIBILITY	28
TECHNICAL REVERSIBILITY COMPONENTS, ELEMENTS AND BUILDING LEVEL	29
MATERIALS	29
4.4. BUILD REVERSIBLE IN CONCEPTION	32
DESIGN APPROACH	32
ASSEMBLY	38
DISASSEMBLY	42
ASSUMPTIONS OF THE TRANSFORMATION	44
PREPARATION OF THE TRANSFORMATION	46
4.5. GREEN TRANSFORMABLE BUILDING LAB	48
DESIGN APPROACH	48
ASSEMBLY	54
TRANSFORMATION	58
4.6. REVERSIBLE EXPERIENCE MODULES	60
DESIGN APPROACH	60
RELOCATIONS	64
4.7. CIRCULAR RETROFIT LAB	66
DESIGN APPROACH	66
EXTERIOR RETROFITTING	70
INTERIOR TRANSFORMATION	72
WORKSITE	86
LESSONS LEARNED	90

5. DATA SHARING THROUGH MATERIALS PASSPORTS DEVELOPMENT	
5.1. REMs: A PHYSICAL SUPPORT FOR TESTING DIGITAL PASSPORTS	94
THE PLATFORM	94
INTERACTION BETWEEN THE PLATFORM AND PHYSICAL MATERIALS	95
CONCLUSIONS	95
5.2. DECENTRALISED OPEN INFORMATION	96
5.3. THE RIGHT INFORMATION FOR THE RIGHT USER	97
6. CIRCULAR LIFE CYCLE ASSESSMENTS	
6.1. BRIC - A CIRCULAR LCA	100
AKNOWLEDGEMENT	100
BRIC- CIRCULAR BUILDING ASSESSMENT	100
ENVIRONMENTAL ASSESSMENT METHODOLOGY	100
BUILDING INFORMATION	100
ANALYSIS	104
CONCLUSIONS	105
6.2. ENVIRONMENTAL ASSESSMENT METHODOLOGY DEVELOPED BY VITO (PROTOTYPING PHASE)	106
GTB LAB PROFILE	106
CRL INTERIOR WALLS	107
6.3. REMs WASTE REDUCTION	108
6.4. EXCEEDING EXPECTATIONS	109
7. BUSINESS MODELS	
7.1. BAMB PILOTS WORKING WITH NEW MARKET PLAYERS AND EXPLORING NEW BUSINESS MODELS	112
INDUSTRY TRANSFORMATION	112
BUSINESS TRANSFORMATION	114
WHAT'S NEXT?	114
7.2. WHAT WE LEARNED FROM PROTOTYPING- LIFE CYCLE COST (LCC)	116
8. STAKEHOLDER ECOSYSTEM	
8.1. WHAT WE LEARNED FROM PROTOTYPING	120
8.2. WHAT WE LEARNED FROM THE BUILDING PHASE	120
VALUE NETWORK	120
CO-CREATION	121
COORDINATION	121
8.3. NEXT STEP: EXTENDED NETWORK, CLOSE THE LOOP	121
9. POLICIES AND STANDARDS	
9.1. LEARNING FROM THE PILOTS	126
9.2. BEYOND THE CONSTRUCTION INDUSTRY	129
9.3. CIRCULAR MIND-SET	129
10. ENDNOTES	
11. BIBLIOGRAPHY	

1. BUILDINGS AS MATERIAL BANKS

1.1. A SYSTEMIC APPROACH

Designing buildings as repositories of valuable materials is a concrete contribution towards the development of a circular construction industry. The “Buildings as Material Banks” H2020 innovation project has provided **practical** answers for **the preservation of raw materials and the implementation of waste reduction strategies and solutions**. The project has identified actions along the construction industry activities¹ and given in-depth insights into the necessary **changes within the value chains** to support the **circular economy transition**.

The Buildings as Material Banks project has contributed to the creation of a new culture of “**recovery, re-use, and upcycling**”. The team developed protocols and tools for **reversible building design**², addressing different layers ranging from materials through components to buildings.

The project seizes the opportunities offered by digitalisation through the development of more than **400 Material Passports** and by creating a **Circular Building Assessment tool**.

Materials Passports are electronic and inter-operable data sets that collect characteristics of materials and assemblies. They enable building stakeholders to better capture the value of products they use by extending their life span.

The Circular Building Assessment tool³ assesses the transformation capacity, and reuse potential of buildings. It allows efficient data management at project level to generate optimal decision-making models for the stakeholders.

The research process developed during the project has provided insights into **how policies and standards** can shape the systemic shift. It helped identify new **needs and opportunities for emerging businesses** in the industry.

1.2. PILOT PROJECTS

In order to maximise BAMB’s innovation potential, dissemination impact and stakeholder involvement, six pilot projects tested and demonstrated the project outputs in various settings.

The pilot projects investigate and demonstrate new design approaches to making buildings more flexible throughout their life. From the start, they focus on reversible conception, manufacturing to increase the quality of materials and products, on construction and maintenance, integrating the re-design phase of the building within the process (Figure 3).

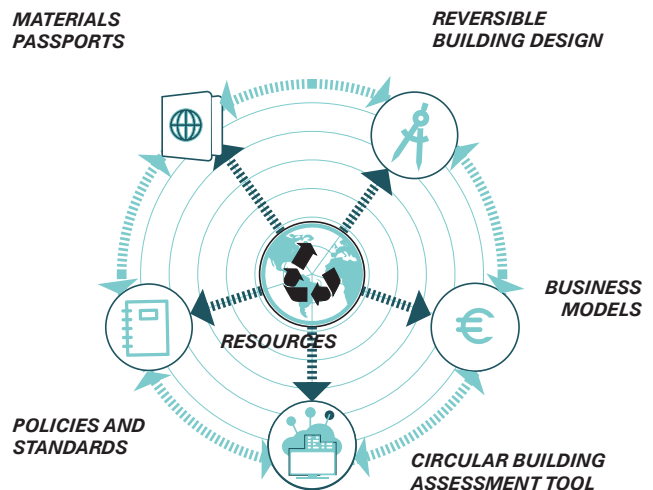

Figure 1: Towards a circular construction ecosystem
Buildings as Material Banks Horizon2020 Innovation project

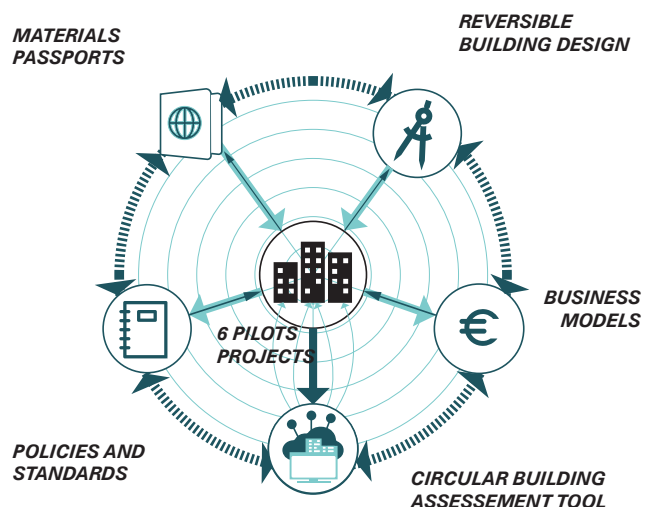

Figure 2: Articulation of the pilots projects around the Buildings as Material Banks Horizon2020 Innovation project's major topics

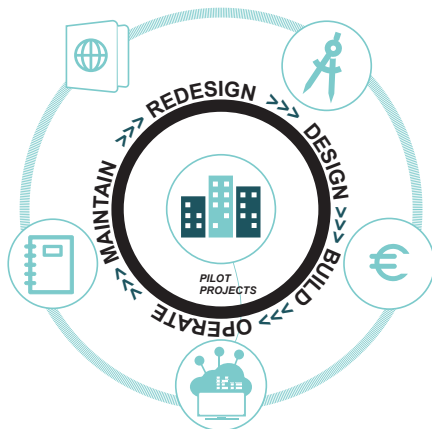

Figure 3: A new life-cycle approach in the construction industry, enabled by BAMB tools

The whole pilot development process highlights concrete opportunities to capture more value from resources while offering a better, more liveable built environment to users.

The real scale projects are providing information about different stages of the buildings' life cycle. They include design phases, prototyping phases, actual constructions or renovations, dis-assemblies, and ultimately the transformation of the buildings while limiting waste generation. They have provided valuable insights about the role of each stage in achieving circularity.

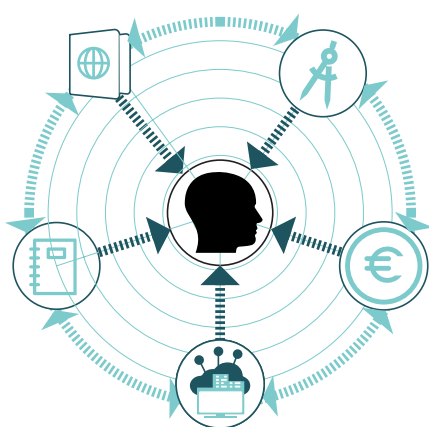

Figure 4: In a circular economy, the user's needs and consciousness about environmental challenges are key for a successful transition

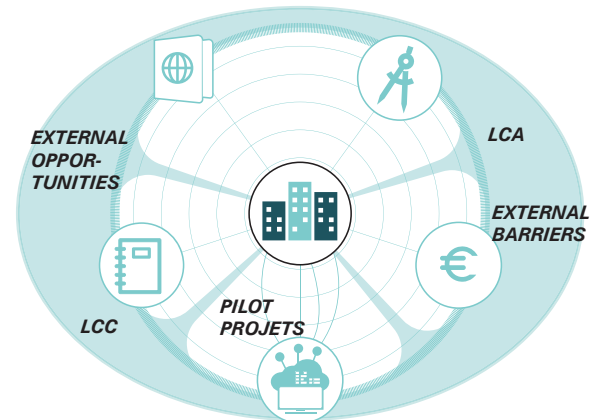

Figure 5: Integration of the broader societal challenges and of environmental cost and impact into the circular reflection

Yet, achieving circularity requires important change in the way people think about their built environment. Aware of these major societal challenge, the BAMB team worked on development scenarios and strategies to overcome barriers and to ease the path towards circular human settlements (Figure 5).

1.3. LABORATORY OF CIRCULAR KNOWLEDGE

The pilot projects are real laboratories for circularity that:

- **integrate reversible design concepts (transformation capacity and re-use potential) at different levels, providing flexible buildings, creating independent systems (envelopes, interior walls, roofs...)**
- **highlight the "re-use" potential of materials, by proving that their economic value can be preserved throughout several transformations**
- **identify necessary changes in project governance. In order to achieve circularity, the project's stakeholders need to be involved upstream, in a collaborative design process**
- **prove the importance of linking physical buildings and digital systems to maximise (re)use opportunities**
- **provide feedback on supporting activities in the value network (e.g. procurement, etc.).**

2. REPORT SUMMARY

1.1. TESTING BAMB RESULTS THROUGH PROTOTYPING AND PILOTS

The reversible building design approach, the Materials Passports, the Circular Building Assessment Tool and new business models for a circular material value network developed in BAMB have been tested in pilot cases within the project’s work package 4 (WP4).

This was done in three steps, each leading to a separate report on its findings:

- The *pilot projects’ feasibility study (D12)* published in August 2017,
- The *prototyping report (D13)* describing the manufacture of prototypes and providing feedback published in April 2018,
- The present report on the built pilots (D14) published in February 2019 contains the results of the construction of four pilots.

Following the feasibility study, prototyping key elements of the pilot projects was an essential first step to materialise, test and improve building elements and systems in order to maximise the building’s circularity. The process assessed how certain building products and systems (existing or newly designed) could be transformed and disassembled during the building phase with minimum waste generation and limited use of natural resources through improved reuse, refurbishment, and recycling.

Taking into account the results and feedback from the feasibility report and the prototyping, **the construction process** provided rich information on how a successful circular project should be shaped from the very start.

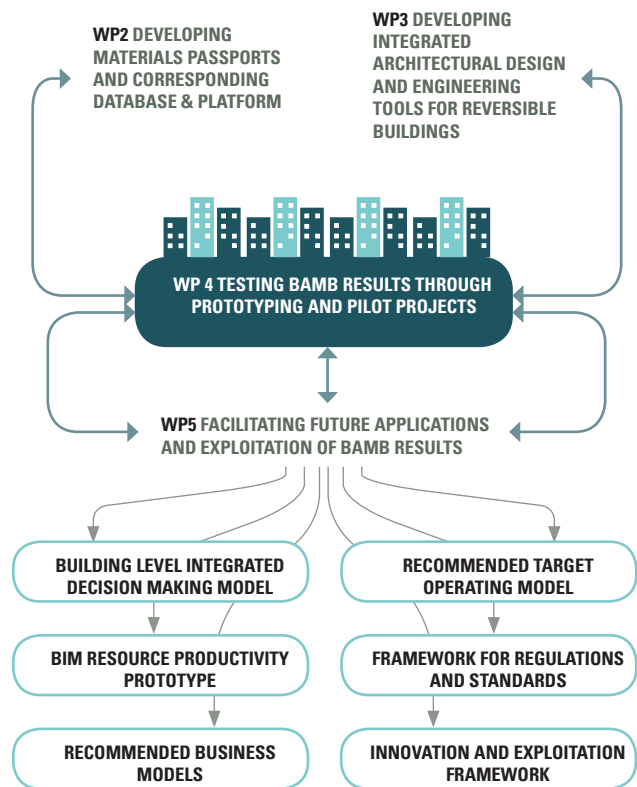

Figure 7: Testing BAMB Results Through Pilot Projects

WP 4 TESTING BAMB RESULTS THROUGH PROTOTYPING AND PILOT PROJECTS

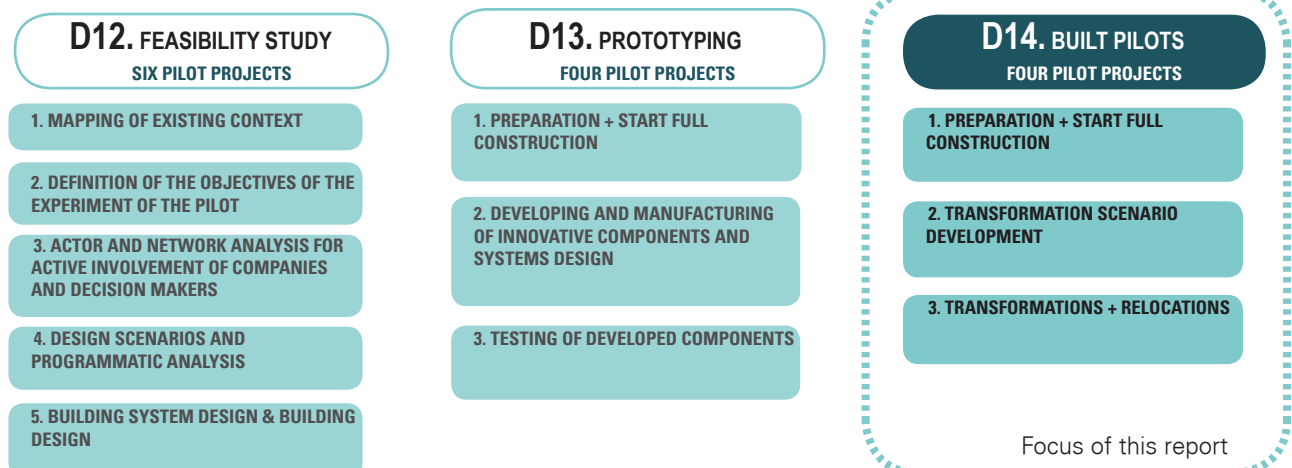

Figure 6: Overview of the pilot projects and BAMB work package 4 (WP4) actions

2.1. PILOTS BUILT AND FEEDBACK REPORT

The objective of the present report is to provide an overview of the essential insights and outcomes of the construction of four circular pilot projects out of the six BAMB pilot projects :

- Green Transformable Building Lab (GTB Lab)
- Reversible Experience Modules (REMs)
- Circular Retrofit Lab (CRL)
- Build Reversible in Conception (BRIC).

This information has been gathered from the four pilot studies provided by pilot project leaders. Designed as a synthesis, the D14 report focuses on BAMB's innovation goals, the identification of lessons learned and recommendations that emerged from the process.

The responsible partner and coordinating author of the present report is Brussels Environment. Partners in charge of specific pilot projects have contributed with individual reports and analyses. Action 1, GTB Lab was managed by Green Design Center. Action 2, REMs was led by EPEA, Netherlands. Vrije Universiteit Brussel was in charge of the CRL, Action 4. Brussels Environment together with efp Training Center managed Action 5, the BRIC project. Building Research Establishment (BRE) the developer of the Circular Building Assessment tool realised the LCA analyses.

The report is structured around the following chapters:

1. Description of the Pilots

This chapter provides a short overview of the pilots. Each project and its reversible concept are briefly introduced. The chapter describes the overall objectives, highlights the innovative solutions and the achievements. It showcases the ambition and motivation of the project developers as a key driver for developing sustainable and circular solutions.

2. Reversible Building Design (RBD)

Making use of the pilot projects, the BAMB team has tested the reversible design protocols used in work package three (WP3). The development of the design protocols and catalogue has a strong theoretical background, but pilot projects focus on the most practical aspects, such as expected lifetime, how materials and components can be demounted, reused or recycled, what is the performance over time, the health aspects and sustainability of the materials, and their market value over time.

3. Materials Passports (MP)

Once data is collected on the Materials Passports platform, more effective reversible design building solutions can be

drawn. Owners, designers, and users can anticipate future functional needs by both designing flexible buildings and utilizing re-used products and materials. Demountable, adaptable and reusable, no-waste solutions can increase reversibility. The chapter explores how the pilot teams used the work developed in work package two or how they developed their own system adapted to the intrinsic logic of the project.

4. Environmental Assessment

Quantitative environmental criteria allow for the continuous evaluation of the achievements related to the initial objectives (e.g. reduction of waste, CO₂ emissions...). Two value proposals for the project BRIC are assessed through a circular Life Cycle Assessment

5. Business Models Circular Opportunities

The chapter highlights important aspects, such as ownership transfer, leasing versus purchasing, and changes in the value network. It takes into consideration financial aspects and how opportunities and long term profitability can be improved during the extended lifespan of a circular building. The innovative strategies developed by each team and their capacity to propose new value proposals for the existing and new markets are evaluated.

6. A new business ecosystem. This chapter presents an overview of the stakeholders and their contributions to each project. A circular economy involves a process-based approach. The interaction with stakeholders during the conception, prototyping and building phases, the co-creative aspects and the upfront intervention of players traditionally positioned at the back end of the value chain are highlighted in this chapter.

However, the key to achieving a strong value network of stakeholders resides in operational effectiveness. Insights of the projects are highlighting the need for lean operational approaches.

7. Policies and Standards

The pilot projects, realised under realistic market conditions and constraints identify both current barriers to develop circularity and opportunities to foster collaboration amongst a value network of stakeholders. Needed changes to achieve circularity include improved partnership between public and private organisations, and enhanced coherent industry support. Companies managing the projects, and public bodies alike would benefit from internal transformations and more fluidity in decision making in order to support the successful circular transition. The pilot projects highlight the barriers encountered during various project development stages. Based on the findings developed in work package five, policy priorities related to the case studies are highlighted.

BUILDINGS AS MATERIAL BANKS PILOT PROJECTS

3. GENERAL PRESENTATION OF PILOT PROJECTS

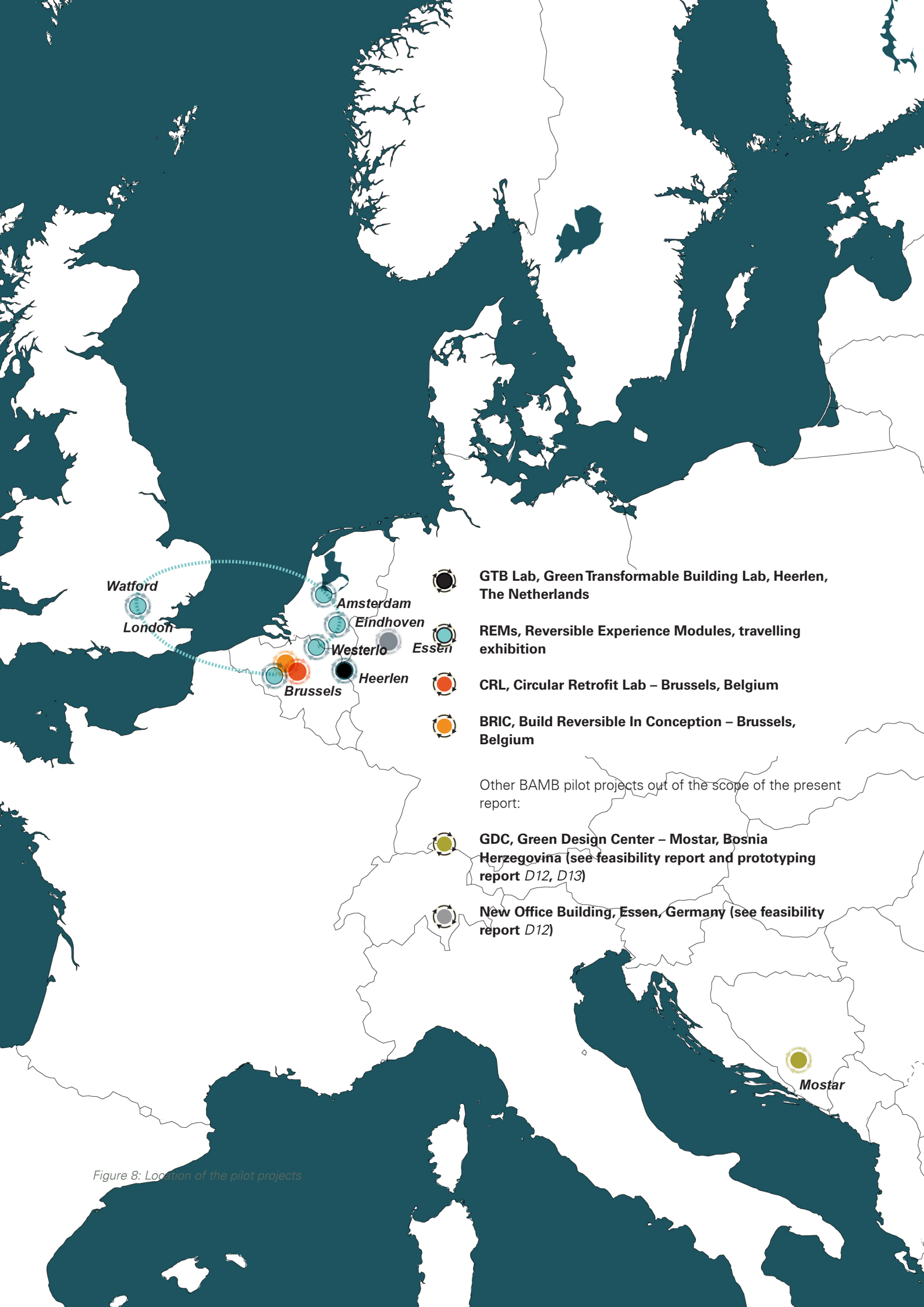
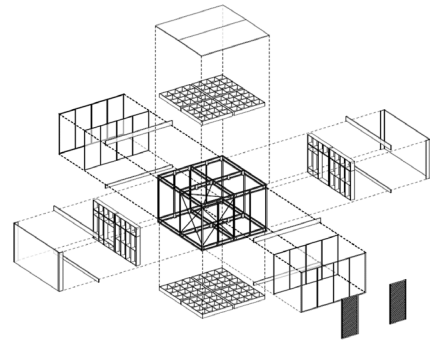

Figure 8: Location of the pilot projects



GTB Lab



REMs

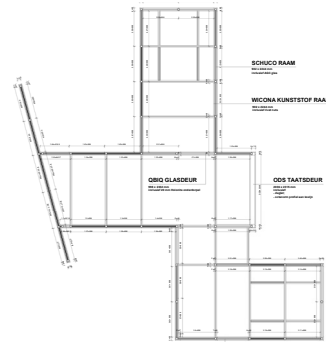

CRL

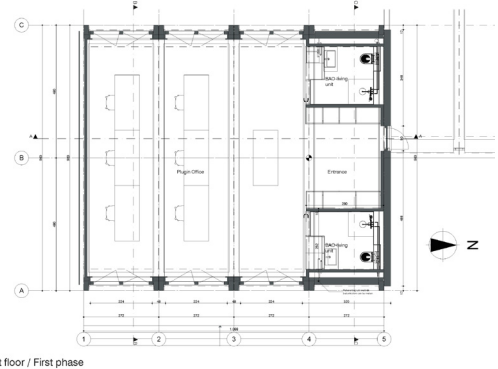

BRIC

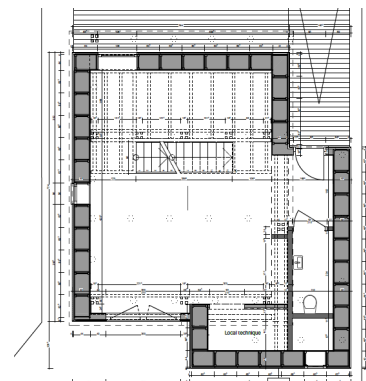

Project developer:

Sarajevo Green Design
Foundation

Architects:

4D architects

Contractor:

ODS kloeckner ,Skellet,
Pilkington Nederand B.V.,
TheNewMakers, Rodeca,
Ammanu

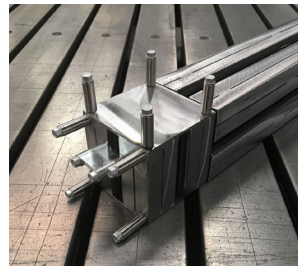

**GTB Lab Profile
PROTOTYPE 1**

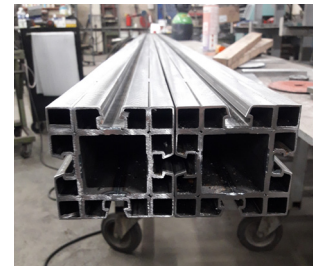

**GTB Lab Profile
CONNEXIONS 1**

Project developer:

EPEA, Netherlands,

Architects:

&Lotte design studio

Contractor:

Gielissen interior builders

Products

Octanorm, Hunter Douglas,
Faber Exopsize, Bsw, Ami,
Desso



**REMs PROTOTYPE 1
MODULE**

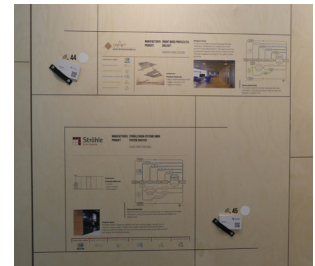

**REMs PROTOTYPE 1
INTERFACE**

Project developer:

VUB, Brussels

Architect + engineering:

Kaderstudio, MK Engineering

Worksite coordinator:

Groep Van Roey

Products:

Geberit, Saint-Gobain, Reynaers, Jonckheere
Projects, Beneens, Jaga,
Zehnder Group, Lumency, Bao
Living, Systimber, JuuNoo



**GEBERIT
PROTOTYPE 1**



**SAINT GOBAIN
PROTOTYPE 2,3**



**Wall linQ
PROTOTYPE 4**



**SYSTIMBER
PROTOTYPE 5**

Project developer:

EFP, Brussels

Architects:

Map Architecture, Karbon
Architecture

Consultancy:

VUB, Pierre Berger S.A.

Contractor:

EFP, Fulltherm sprl, Evocells



**BRIC
INSULATION BOX**



**BRIC
COLUMNS**

BRIC

An educational transformable wooden building

Focus:	<ul style="list-style-type: none"> • Provide circular building knowledge and skills to the construction sector on: reversibility and transformability, sustainability, reclaimed materials, and efficient resource management with a focus on short value chain loops, and energy efficiency. • Involve local actors by stimulating interest in circularity among building stakeholders, such as architects, contractors, manufacturers, resellers...
Type:	New building, Disassembled and assembled twice
Size:	Minimum size: 70 m ² (2018); maximum size: 130 m ² (2019)
Function:	An office building (2018), a shop (2019) and eventually an acoustic laboratory (2020)
Location:	EFP, Brussels, Belgium

3.1. BUILD REVERSIBLE IN CONCEPTION (BRIC)

PILOT SUMMARY

Entirely built by young trainees, the BRIC building is a sustainable, scalable and reversible construction developed by the interdisciplinary Brussels training centre, EFP during three consecutive academic years, starting in autumn 2017. BRIC is being assembled and disassembled on a yearly basis. Each transformation is accompanied by a change in function: from an office (2018) to a shop (2019) and eventually an acoustic laboratory (2020) for training EFP students.

The first construction set-up in 2018 (BRIC 1), tested the capacity of a wooden construction to integrate reclaimed materials, applying reversible solutions that minimise the waste during transformations.

OBJECTIVES

By the end of 2018, more than 180 students had participated in the construction and disassembly of the first BRIC module. The first construction and disassembly proved the convenience and feasibility of integrating circular building techniques. The integration of the transformation phase into the design process provided a better forecast of the ability to recover materials and maintain their value.

INNOVATION

BRIC is a unique project that actively involves young people, the future construction professionals and entrepreneurs. It is an ongoing interdisciplinary laboratory of knowledge where students and experienced professionals exchange ideas and co-create the project all along its development. An open-minded approach allowed the re-assessment and redefinition of traditional stakeholder roles in the conception, construction, operation, deconstruction and re-assembly phases.

BRIC is testing a set of constructive elements in a circular configuration. Bidirectional structural columns, interchangeable insulation boxes, screwable foundations,...

ACHIEVEMENTS

Conceived as a material bank, BRIC tested the extension of the lifespan of materials. The team analysed the capacity of each constructive element to be reused several times with almost no waste production. The first technical results proved that both circularity and energy efficiency objectives can be successfully met within the same project. For example, the BlowerDoor test, which measures the airtightness of the building, generated an excellent result ($v_{50}=1,6\text{m}^3/\text{h}/\text{m}^2$).

REPLICABILITY AND SCALABILITY

During its transformations, the project is testing the capacity of the construction to evolve in size and functionality. The ability of the project to be transformed and adapted to new functional needs makes BRIC a valuable scalable project. Making use of its reversible characteristics, such as the removable foundation, the building can be implemented in different places with a minimal ecological footprint and ease of assembly to accommodate different functions.

The BRIC concept is a perfect candidate for temporary occupation projects, such as seasonal shelters, which can meet the needs of niche market segments not necessarily covered by current construction industry offers.



> REVERSIBLE DESIGN P.24

> MATERIALS PASSPORTS P.92

> ENVIRONMENTAL IMPACT P.98

> BUSINESS MODELS P.110

> POLICIES & STANDARDS P.124

GTB LAB

A transformable steel framed building module with exchangeable components.

Focus:	<ul style="list-style-type: none"> • Testing the transformation of the shape, size, and function of a building through the use of Reversible Building Design protocols and standards • Investigate needs and requirements of the local stakeholders to develop new business models
Type:	New Construction, assembled and transformed once
Size:	Single module size: 24 m ² (2019); potential subsequent up-scaling
Function:	Multifunctional space for changing daily uses, potential functions: work lounge, meeting space, lecture hall and housing unit
Location:	ODS Klockner, Ridderkerk, The Netherlands

3.2. GREEN TRANSFORMABLE BUILDING LAB (GTB LAB)

PILOT SUMMARY

Realised in the framework of the GTB innovation centre for circular building in Heerlen, the Green Transformable Building Lab (GTB Lab) module has been developed around a reversible multifunctional steel frame which was filled by independent, exchangeable, standardised and reversible floor, facade and roof components.

To date, a single module has been built with the newly developed components: universal steel profile, standardised reversible wooden cassette, glass heated façade. The GTBL is intended to be up scaled subsequently.

OBJECTIVES

Green Transformable Building Lab develops, tests and demonstrates reversible building design e.g. building products and elements in an operational environment.

In order to provide independence and exchangeability of building elements, the pilot focused on the reversibility of interfaces between different building components, the standardisation of connections and dimensions of exchangeable components.

INNOVATION

GTB Lab investigates the development of entirely new circular products by completely switching from the traditional construction approach. The Lab was designed as an open platform. By introducing plugins in building components, the structure was and will be able to change form and function. It can adjust its configuration to the required performance without substantial loss of value of materials while providing optimal comfort, healthy climate, and local energy production.

The joint participation of the construction industry in the development of the GTB LAB enabled the investigation of new business and operational models that makes a circular project feasible.

ACHIEVEMENTS

The module was built in Barendrecht, Netherlands. Since its construction in December 2018, the flexible and evolving structure was transformed once. In the future, the construction is intended to be scaled up, receive a specific functionality, and eventually be transformed several times. Today, the footprint of the metal as a material for construction is assessed based on the end of life recycling scenario. The biggest achievement of the GTB Lab is to demonstrate the necessity to change these assumptions. Not only should the reuse scenario be taken into consideration, but the impact of upgradable standardised modular systems and exchangeable components should be integrated and enhanced in the calculation. Their implementation is likely to drastically reduce the material footprint and waste creation.

REPLICABILITY AND SCALABILITY

The standardisation, universal connections between different elements, and the correlation between the lifespan of materials are solutions that can be integrated in the construction industry of tomorrow.



> REVERSIBLE DESIGN P.24

> MATERIALS PASSPORTS P.92

> ENVIRONMENTAL IMPACT P.98

> BUSINESS MODELS P.110

> POLICIES & STANDARDS P.124

REMs

An indoor interactive and modular exhibition space on circular building materials.

Focus:	<ul style="list-style-type: none"> • Promote the benefits and the use of Materials Passports by providing direct access to the Materials Passports Platform through the different construction products displayed in the exhibition. • Improve and test the upscaling potential of a transformable and adaptable kit-of-parts exhibition module.
Type:	New Construction, Assembled, transformed and relocated six times
Size:	Minimum size: 40m ² ; maximum size: up to 100m ²
Function:	Travelling exhibition of circular materials and materials passports
Location:	Brussels (BE), London (UK), Watford (UK), Amsterdam (NL), Eindhoven (NL), Westerlo (BE)

3.3. REVERSIBLE EXPERIENCE MODULES (REMS)

PILOT CONCEPT

The Reversible Experience Modules (REMs) form a traveling interactive exhibition on circular building, which displays 70 products and systems designed for reuse, recovery, and recycling in circular buildings. Each material and product inside the REMs exhibition is available on the market and labelled with a Materials Passport. Visitors of the exhibition can manipulate the products and gain direct access to the online Materials Passport data for each by scanning the product's QR code with their phone.

The structure itself was designed and built applying a reversible building design approach. The assembly, disassembly and relocation of the exhibition (six times during one year), showcased the reversibility of the whole setup and its adaptability to different configurations.

OBJECTIVES

The exhibition provides tangible means for professionals from the built environment and others interested to interact and discover the integration of the passports, healthy materials, and reversible design. By continuous interaction with the public, the team has tested the understanding of the passports as a source of valuable interchangeable data to be used within different construction phases and by different players.

Practically the passports are guides on how to detach or disassemble products, the reuse potential of components and the material health. They provide data that helps prevent waste, improve resource productivity, and reduce emissions. Manufacturers and end-users have discovered opportunities for new circular value propositions.

INNOVATION

Based on the experience in other industries, digitalisation is expected to drive innovative disruption in the construction industry. By exploring the relationship between physical products and the related digital data, REMs, the largest traveling exhibition on circular building materials in Europe, supports the prospect of the development of new business models, potential new players, and new market opportunities.

ACHIEVEMENTS

The pilot has been assembled and disassembled six times with almost no waste production. A small set up was presented at Brussels Environment HQ, early 2018. The first full-size construction was presented at Ecobuild, in London in March 2018. In spring 2018, it travelled to Watford, UK and Building Holland. The set up was redesigned for the Dutch Design Week in Eindhoven, just before arriving in Westerlo, Belgium.

The exhibition attracted a large number of visitors: architects, contractors, suppliers, building owners, project developers, and dismantlers. It gathered insightful feedback for the improvement of the BAMB passports ICT platform.

REPLICABILITY AND SCALABILITY

The REMs highlights cross-sectoral opportunities. Being an exhibition module, it uses reversible construction systems conceived for optimised multiple uses. The solutions developed can readily be transferred from exhibition setups to other construction sectors, e.g. partition walls for residential, commercial or health facilities, or temporary setups.

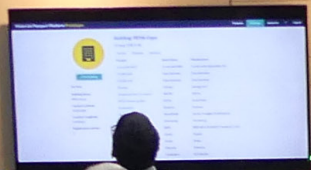

HOW DOES THE MATERIALS PASSPORT WORK?

1. Material passport data is collected from the building information model (BIM) and the material passport (MP) data is stored in a central database.

2. The data is then used to generate a material passport for each building component.

3. The material passport is then used to track the material's lifecycle and to ensure that it is recycled at the end of its life.

STEP BY STEP MATERIAL BY MATERIAL, BUILDING BY BUILDING, WE WILL BUILD OUR CIRCULAR FUTURE OVER AND OVER AGAIN. MATERIALS PASSPORTS ARE OUR TRAVELGUIDE.

WHAT IS A MATERIAL PASSPORT?

A material passport is a digital record of the materials used in a building, from their origin to their end-of-life. It provides a clear and concise overview of the building's material composition, enabling stakeholders to make informed decisions about the building's future.

> REVERSIBLE DESIGN P.24

> MATERIALS PASSPORTS P.92

> ENVIRONMENTAL IMPACT P.98

> BUSINESS MODELS P.110

> POLICIES & STANDARDS P.124

CRL

Full renovation of prefabricated student housing modules for multiple uses

Focus:	<ul style="list-style-type: none"> • Reversible building design aspects, replicability, through “research by design” and “process approach” perspective. • Foster stakeholder involvement in order to identify business models
Type:	Refurbishment, integration of transformed elements
Size:	180 m ²
Function:	Exhibition and office space, eco guesthouse
Location:	VUB Campus, Brussels, Belgium

3.4. CIRCULAR RETROFIT LAB (CRL)

PILOT SUMMARY

The pilot project tested and implemented different scenarios for the reuse and refurbishment of the VUB campus’ prefabricated student housing of the 70s, without generating a large amount of waste. Strategies have been explored for internal transformations, external transformations, and the module’s multiple functional reconfigurations.

Depending on their expected rate of change in the floor plan, three different types of walls were defined, analysed, constructed and transformed: walls with (1) a high rate of change, (2) a high degree of flexibility for the integration of technical infrastructure and (3) a low rate of change.

OBJECTIVES

The circular refurbishment tested dismantlable, adaptable and reusable solutions for maximizing waste reduction.

The pilot developed a co-creative process all along the (re) design, (re) build, (re)use, repurpose or dismantling phases. This necessitated a close collaboration with all the value network stakeholders and future users in the early development phase.

The university organised several round tables with industry stakeholders where design solutions were debated and improved, as well as hands-on workshops with students where solutions were tested.

INNOVATION

The CRL pilot project applied a step-by-step innovation strategy based on products available on the market. This strategy thus incrementally improves products that are already technically and commercially viable.

Selected products, such as partition walls, had a high initial potential to reach circularity objectives. Together with the manufacturers, the team sought to add new product capabilities, such as new functionality (ex. from a prefabricated service module to a fully reversible partition wall system), reversible connections, etc. and test their application in a practical retrofitting project.

ACHIEVEMENTS

The reversible solutions for internal walls and façades have been integrated in the CRL lab by January 2019. The use of modular, prefabricated and kit-of-parts design approach not only fostered flexibility in assembly and efficiency in manufacturing but allowed scaling up the implementation. In this respect, the team together with the industry partners implemented efficient operational solutions, such as the use of dry connections, robust and reversible technical systems and the use of materials able to endure multiple reuses without being damaged.

REPLICABILITY AND SCALABILITY

CRL is likely to serve as a circular renovation model for the other student housing modules located on the VUB campus. The team paid a special attention to the needs of potential users. In this respect, the project reflects on potential business models able to cope with the evolution of the users’ requirements, thus enhancing the reproducibility and perpetuity of a flexible model.



> REVERSIBLE DESIGN P.24

> MATERIALS PASSPORTS P.92

> ENVIRONMENTAL IMPACT P.98

> BUSINESS MODELS P.110

> POLICIES & STANDARDS P.124

ARE YOU INTERESTED IN REVERSIBLE DESIGN?

4. ASSESSMENT OF CONSTRUCTION, DISASSEMBLY, TRANSFORMATION AND RELOCATION



“REVERSIBLE BUILDING DESIGN ENABLES RESOURCE EFFICIENT REPAIR, RE-USE AND RECOVERY OF BUILDING MATERIALS, PRODUCTS AND COMPONENTS SINCE DIFFERENT LAYERS INCLUDING FLOORS, WINDOWS, ELECTRIC CORDS, VENTILATION, INNER WALLS CAN BE ACCESSED WITHOUT DAMAGING OTHER PARTS OF THE BUILDING AND COMPONENTS CAN EASILY BE REMOVED OR REPLACED”. © BAMB

WHY REVERSIBLE DESIGN ?

4.1. GENERAL CONTEXT

LIVING PATTERNS IN TRANSITION

Throughout history, the social and economic organisation of society has shaped human settlements. The spatial configuration, from the urban to the building scale, has always reflected the evolution of the relationship between individuals and groups, the private and public realm, human nature and culture...

Buildings reflect the way people live, work, and move, how food consumption, health, education, and comfort are approached. **The refurbishment of existing buildings** continuously modifies existing spatial patterns to host new cultures of spatial usage. This continuously “up-to-date” process highlights changing needs in terms of privacy or need for community and openness, structure or disorder, inclusiveness or homogeneity...

Yet, today the lifestyles and the way society functions are changing faster than ever. Emerging technologies and digitalisation are transforming the pace of contemporary life in an endless and unpredictable movement. Changes in the workplace, displacement of working spaces, new shared workspace setups, merging of living and working functional spaces through telecommuting, changes in mobility habits, changing in the way goods are produced, consumed and obtained, how we access information are only some of the aspects that impact our lives and stimulate our resilient capacity to cope with future uncertainty. In a slow-moving (construction) industry, spatial flexibility is increasingly required to fast accommodate change.

Within a society moving towards more horizontal decision-making, taking into account diverse and changing needs, reversible design strategies provide opportunities for efficient and versatile spatial configurations.

CONSTRUCTION SECTOR

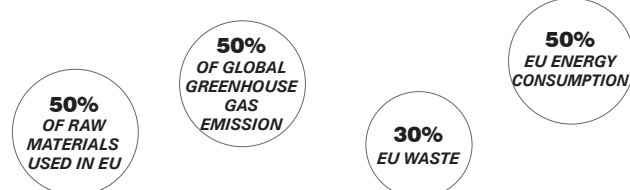

Figure 9: Overview of the construction sector environmental impact ⁵

ENVIRONMENTAL LIMITS

Climate change impacts the natural equilibrium of our planet. As a consequence of increasing human activity, the construction industry are major producers of CO₂ and other greenhouse gas emissions. By 2100, according to medium growth scenarios, the world population will count 11.184.368 inhabitants (Figure 10), causing resources for sustainable growth to become an increasing global challenge. Raw materials are becoming scarce while waste is increasing. **Waste** thus has the capacity **to become a precious asset** for future developments. Making this happen requires a paradigm shift to reduce waste and creating re-use solutions.

URBANISATION Disequilibrium

Through the intense economic exchange, increased mobility, new patterns of production and consumption, cities and city regions become driving engines of the global economy. Increases in the attractiveness of the cities led to unprecedented concentrated population growth and land cover impacts, replacing traditional territorial occupancy system (e.g. sensitive to local and regional resources, climate, topography, flooding, etc.).

Inventories

Territories, regions, cities, and neighbourhoods are like living organisms, with substantial inward and outward movements since WWII. This tremendous and often disarticulated development created a concentration of waste with severe spatial implications in logistics and mobility, along with inefficiencies in the construction process and business development. Not only has waste management become an issue but vacant buildings are also reflecting the lack of optimisation of our resource use.

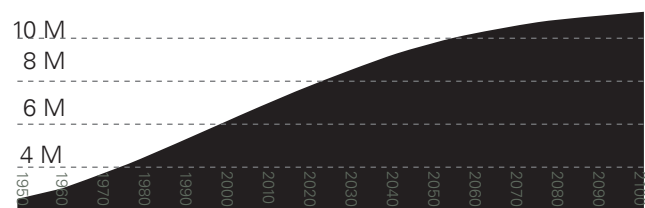

Figure 10: Medium growth scenarios of the world population growth expectation , source: <https://www.oecd.org/>

SYNERGIES BETWEEN SCALES

4.2. BUILDING ENVIRONMENT - THE DNA OF SUSTAINABLE DEVELOPMENT

URBAN SYSTEM

Rethinking architectural and urban design and processes in response to increasing dramatic effects of climate change, urbanisation, scarcity of resources and waste generation cannot be achieved without major transformations along the value chain. Several conditions must be met:

Transition towards circularity must address the growing need of the society **to integrate change and uncertainty** in its living environment.

Buildings should be considered within **their urban and territorial context** as part and parcel of strong urban armatures which integrates closed natural cycle processes (e.g. urban hydrology, biodiversity) into their design thinking.

In a circular economy, the built environment actively plays a role in **closing loops of materials, energy and food production and consumption, responding to the need for proximity, low emission mobility, etc.**

ARCHITECTURE

At the architecture level, reducing the usage of the raw materials and generation of waste by extending the useful life of a building is possible with a clear view of the processes taking place before and after its erection.

In contrast, today the mission and the responsibility of an architect are limited to the design and building phases.

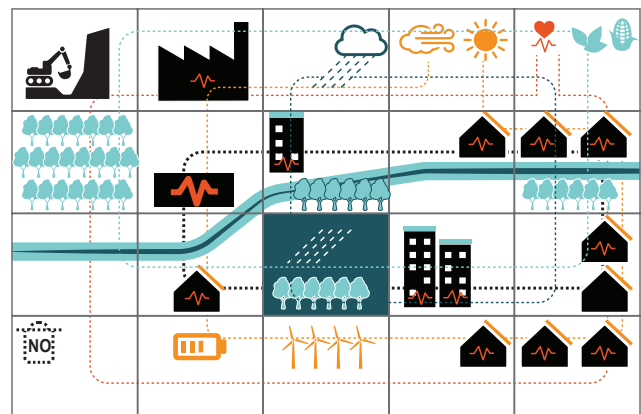

Figure 11: High quality urban structures, (public spaces, and landscapes), sustainable mobility and energy strategies, etc., create conditions for valuable, sustainable and circular buildings. A

Creating an effective circular building means tackling from the start additional life stages of the building such as **operating, transforming, and disassembly stages**. Effective scenarios for subsequent transformation, element exchange, and upgrading must be foreseen from the first conception phase. Moreover, the ecological footprint, costs and impacts of the materials and elements used need to be integrated and continuously assessed.

Assessing the real impact of the design during several processes of transformation will allow a continuous learning loop.

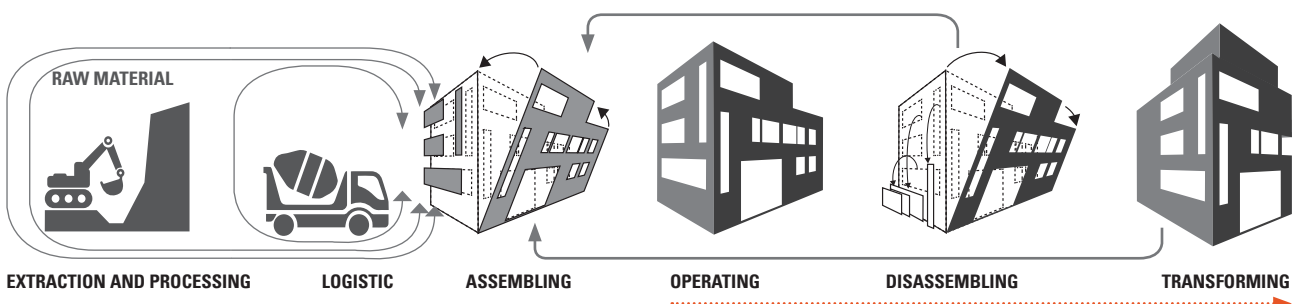
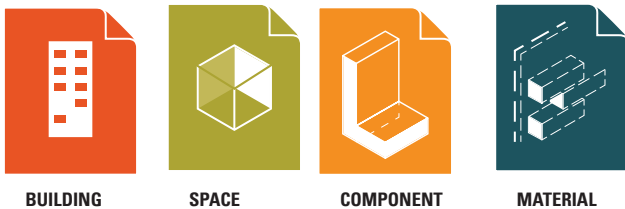

Figure 12: Circular design integrates early reflections on all building stages

4.3. REVERSIBLE BUILDING DESIGN

Buildings are complex systems and circularity has to be analysed at different levels within a construction. Waste reduction criteria and the circular performance of the building should be applied at various scales: **from building level to that of components and constructive systems.** The flexibility of spatial configurations, as well as the capacity of materials to be adaptable are important aspects that need to be integrated from the beginning in the design phase.

This chapter is based on the work developed by the BAMB partner U-Twente.



4.3.1. BUILDING RECONFIGURATION

Reconfiguring a building to respond to growing need for functional changes, urban density policies, etc, should be anticipated from the conception. Not only technical service capacity should be taken in consideration, but also structural capacity to bear loads necessary for future upgrades.

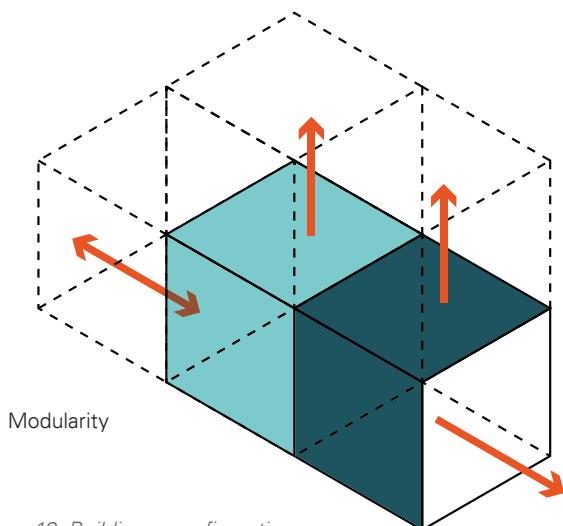

Figure 13: Building reconfiguration



4.3.2. SPATIAL REVERSIBILITY

Spatial flexibility within a building increases its future conversion potential. Whether the building hosts the same functionality but adapts to new living and working patterns, social and organisational changes, or switches to a new function (e.g. housing to office, and vice-versa), different key aspects should be addressed during the conception phase:

- **Dimensions** should ensure architectural quality and comfort, safety, etc. for mono-functional and cross-functional transformations
- **Functional independency** should allow independent juxtaposition of functions
- **Position of the core elements**, including structure, services, vertical circulation should be able to serve multiple functions and reconfigurations.

Scenario thinking and research by design allows modelling possible future plan layouts.

Dimensions
Functional interdependence
Position of core elements

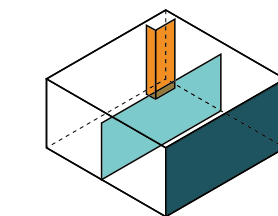

Scenario thinking
█ Technical services
█ Unit separations
█ Internal partition
█ Envelop

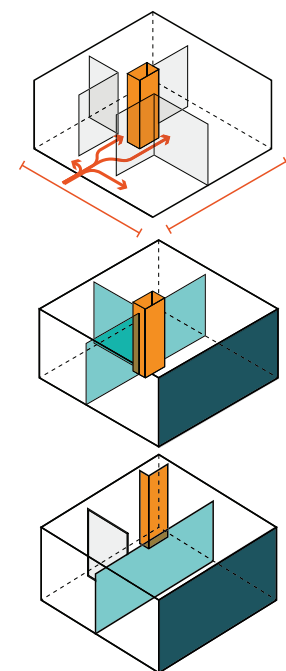

Figure 14: Spatial reversibility



4.3.3. TECHNICAL REVERSIBILITY COMPONENTS, ELEMENTS AND BUILDING LEVEL

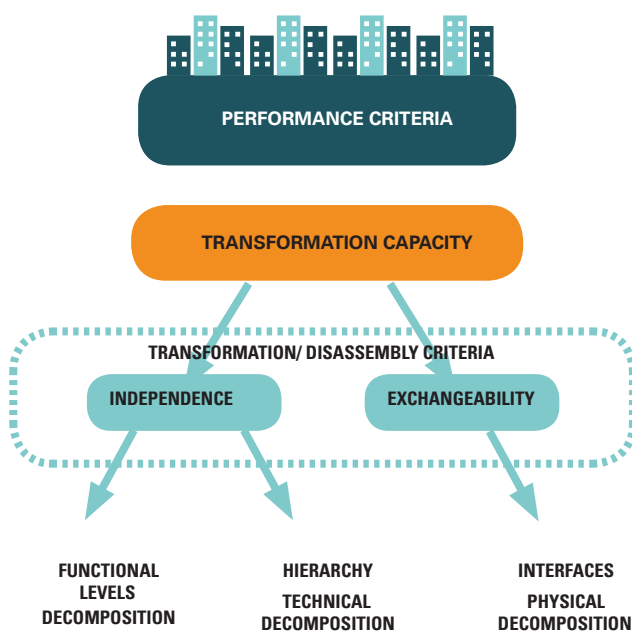

Figure 15: Technical Reversibility Components, Elements And Building Level, Durmisevic model, U-Twente

The **transformation capacity** of a building is assessed by **the independence and the exchangeability** capacity of its components. For the reversible design team, as well for the team developing the circular building assessment tool, these criteria measure the performance of building to become circular.

More **independence** of elements means elements can be easily replaced, upgraded without damaging the whole structure or other elements. **Exchangeability** allows repair, replacement, and multiple uses of elements without creating waste or requiring additional raw materials. Both independence and exchangeability provide an indication of **the reuse potential** of a building.

See the illustrated explanation on the next two pages (Figure 18 on page 30).



4.3.4. MATERIALS

The type of materials used influence the whole construction process and technical approach. The choice of the materials has a tremendous impact on the types of constructive systems and their assembling and disassembling solutions, as well as on the life cycles of a building, systems and components. The re-use potential of materials are changing the paradigms of sustainable construction. Materials considered to have a high environmental footprint, especially in the production phase and recycling phases, can achieve long-term sustainable performance through several utilisations.



Figure 16: Types of materials used in the BAMB pilot projects

Different types of material were identified within BAMB and tested through the pilot projects: new materials, processed materials, bio-based materials, reclaimed materials, recycled materials, and recyclable materials. The health impact of the materials their capacity to regulate the interior comfort and their durability are important circular criteria.

In buildings, this materials are used as standalone components or composed in different products.

TECHNICAL REVERSIBILITY COMPONENTS, ELEMENTS AND BUILDING LEVEL

1. INDEPENDENCE

separate elements and materials

1. FUNCTIONAL DECOMPOSITION

SEPARATION BETWEEN FUNCTIONS ON ALL LEVELS
GROUPING OF COMPONENTS AND ELEMENTS OF A BUILDING ALLOW DEMOUNTABILITY

FUNCTIONAL INDEPENDENCE

Separation of functions that have different changing rates and use expectancies



Level of integration of functions within elements and the dependence of functions



BUILD REVERSIBLE IN CONCEPTION

SYSTEMATISATION:

Clustering of elements into an independent module based on functionality, assembly/disassembly, life cycle coordination of elements and their assembly per expected use life cycle



The grouping of sub-systems, open/independent strands of construction/layers

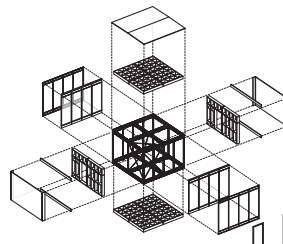

GREEN TRANSFORMABLE BUILDING

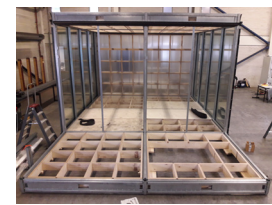

GREEN TRANSFORMABLE BUILDING

1. HIERARCHY & TECHNICAL DECOMPOSITION

DEPENDS ON HOW INDIVIDUAL ASPECTS WITHIN A LAYER (E.G. SKIN) ARE ORGANISED. THIS CAN BE SUB-DIVIDED INTO A STRUCTURE WHICH IS REFERRED TO AS A HIERARCHY OF MATERIAL LEVELS

RELATIONAL PATTERN:

Minimisation of the number of relations representing functional and technical dependencies between elements within a building

The type of relations between individual elements within a building has a significant impact on disassembly potential of a structure. 6 types of relational patterns decide the flexibility of the building



GREEN TRANSFORMABLE BUILDING

BASE ELEMENT

Design of a basic element that functions as an intermediary between the elements within the configuration



CIRCULAR RETROFIT LAB

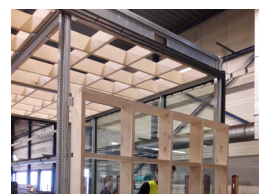

GREEN TRANSFORMABLE BUILDING

LIFE CYCLE COORDINATION

Coordination of use and technical life cycles of elements within buildings in relation to their disassembly sequences

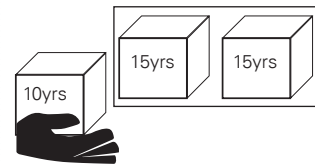

Co-ordination of elements, with those that have a long life cycle and greatest dependencies in assembly



Figure 19: Stewart Brand's 'Shearing Layers' of a building

- 5-15yrs stuff
- 5-20yrs space plan
- 5-30yrs services
- 6-200yrs structure
- 30-60yrs skin
- building site

Figure 18: Adaptation from Elma Durmisevic the Hierarchical structure of knowledge model available from Reversible Building Design Framework 3

TECHNICAL REVERSIBILITY COMPONENTS, ELEMENTS AND BUILDING LEVEL

1. EXCHANGEABILITY

Reconfigure/ upgrade structure

1. INTERFACES PHYSICAL DECOMPOSITION

THIS IS ADDRESSES AT THE INTERFACE OF EACH LEVEL

ASSEMBLY:

Allowing for more parallel than sequential assembly within a building

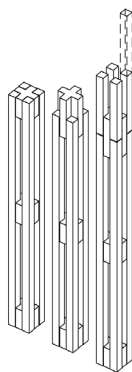

Sequences in assembly create dependencies between building elements, by locking elements together



CIRCULAR RETROFIT LAB

GEOMETRY:

Design the geometry of products' edges that will allow recovery and reuse of elements without damaging themselves or other elements

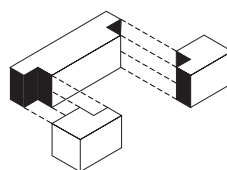

The geometry of the product edge and the standardisation will affect the connections

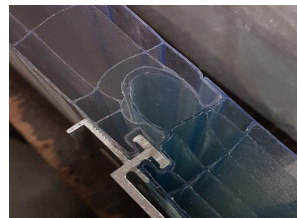
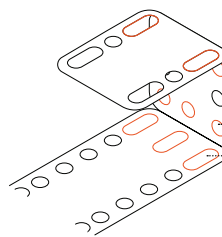

GREEN TRANSFORMABLE BUILDING

CONNECTIONS:

Use type of connection that will allow separation and the recovery of elements.

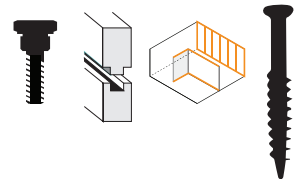

Type of connections: the accessibility, tolerance and morphology of the joint

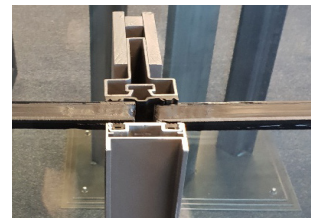

GREEN TRANSFORMABLE BUILDING

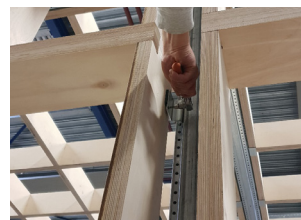

GREEN TRANSFORMABLE BUILDING



GREEN TRANSFORMABLE BUILDING



CIRCULAR RETROFIT LAB



BUILD REVERSIBLE IN CONCEPTION



BUILD REVERSIBLE IN CONCEPTION



CIRCULAR RETROFIT LAB

BRIC

4.4. BUILD REVERSIBLE IN CONCEPTION

CONSTRUCTION DRAWINGS: AS BUILT PLANS (OF EACH TRANSFORMATION/RELOCATION).

4.4.1. DESIGN APPROACH

REVERSIBILITY

Constructed during the 2017-2018 academic year, the first version of BRIC building has been deconstructed in winter 2018. Designed for two successive re-assemblies and dis-assemblies, the project included transformation scenarios for BRIC2 and some incipient idea about BRIC3. Several key strategic criteria were identified:

- each construction has different volume and function
- all the successive buildings use the same materials and maximise their reuse potential
- screwed together or interlocked connections create the opportunity to recuperate, sell, re-use materials after the end of the project
- circularity has been addressed at various levels: building, spatial, system, element and material level

SUSTAINABLE BUILDING

The project combines circular building solutions for reducing waste and minimising environmental impacts, with the aim to close energy and material loops. It challenges the entire value chain. The project tackles topics such as local supply, energy efficiency, and closing urban hydrological cycles.

WOOD AS AN INTRINSICLY CIRCULAR RESOURCE

The BRIC project used bio-based and renewable materials with a focus on wood and wooden derivatives. Characterised by its specific “texture, structure, flexibility, and tension”⁶, the wood takes multiple shapes, provides re-usable and upgradable products, etc. Wood-based products were used to replace as much as possible petrochemical and mineral-based construction materials. Within the production phase, wood demands little energy consumption compared with other products. Moreover, wooden materials sequester carbon, contributing to the long-term storage of atmospheric carbon dioxide. Hence, if well managed, they offer an additional measure to mitigate Greenhouse Gases Emissions. Light and resistant, with insulating properties and the ability to regulate humidity, timber is an important resource for circularity.

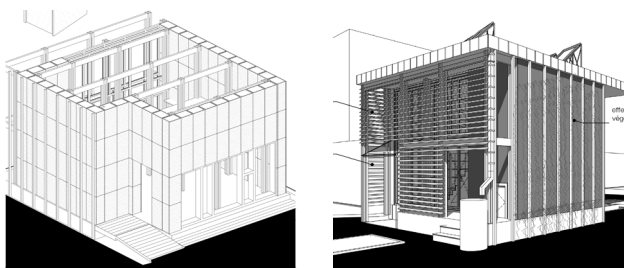

Figure 20: Project BRIC 2, axonometric views (insulation boxes and finishing), groundfloor plan and second floor plan

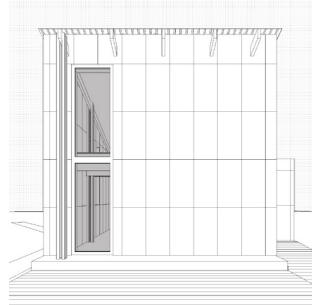

Figure 21: BRIC 1, facades

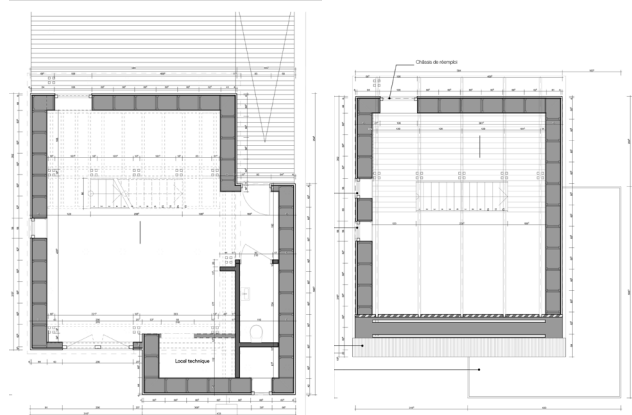

Figure 22: BRIC 1 plans

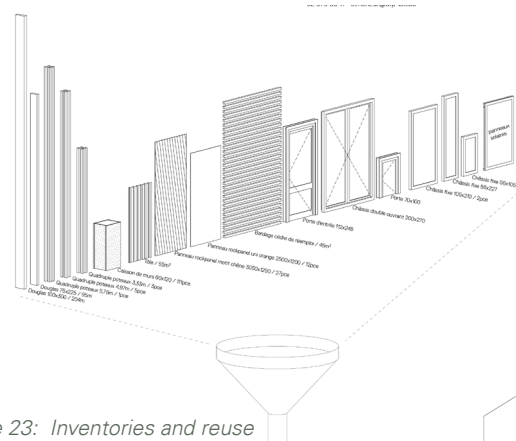
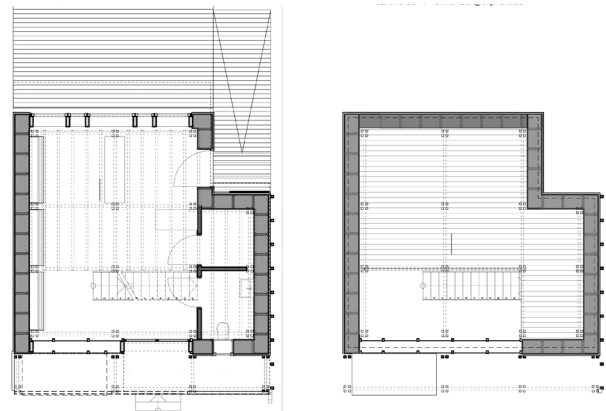
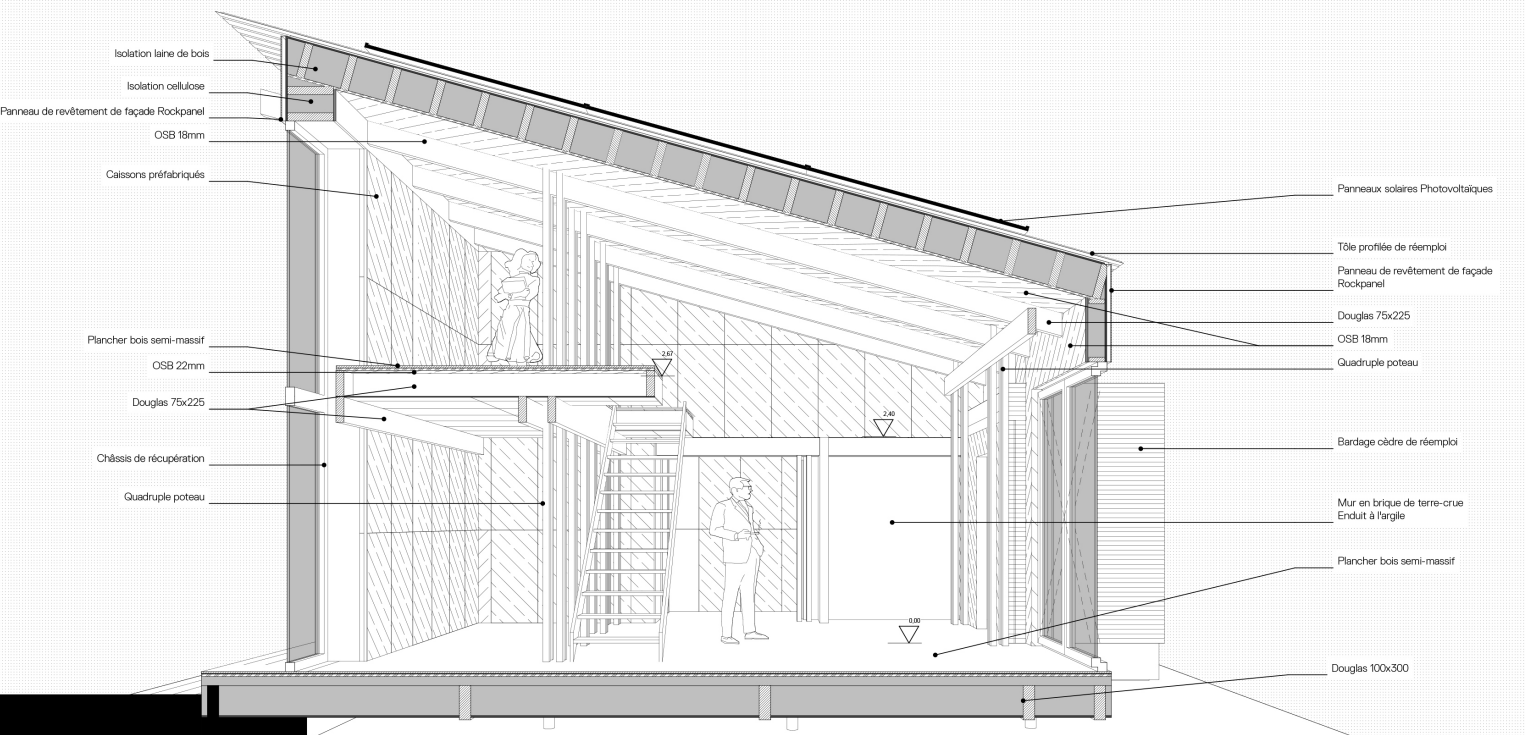

Figure 23: Inventories and reuse strategy for BRIC 2



BRIC 1



317 BRIC

Projet BRIC1 - PLANS AS-BUILD
Rue de Stalle 292 B Bruxelles

Phase Projet
Echelle 1:18,18 / n.a.
Date 9/11/18
Index A

Fiche 09 - Coupe détail

N° Dessin
09

BRIC 2



317 BRIC

Projet BRIC2
Rue de Stalle 292 B Bruxelles

Phase Avant-projet
Echelle 1:18,18 / n.a.
Date 17/09/18
Index A

Fiche 18 - Coupe détail

N° Dessin
18

BRIC 1 BUILD REVERSIBLE IN CONCEPTION

TECHNICAL SPECIFICATIONS AND DETAILS THAT PROVIDE INFORMATION ABOUT THE COMPONENTS WHICH DETERMINE THE REVERSIBILITY.

ROOF COMPOSITION

MATERIAL: Metal sheets are used for the roof covering. The use of metal has a high ecological footprint resulting from the high energy-intensity of production and recycling. However, the sheets life-cycle impact is likely to be reconsidered more favourably, within a circular approach, where the material is designed for several re-uses.

RECLAIMED MATERIALS: the project uses reclaimed metal sheets.

MATERIAL: The roof structure is made from Northern red pine (SRN) hardwood. Glued laminated timber was abandoned due to the irreversible composition of its elements. The use of 22 mm OSB boards, made from industrial wood waste, meets BRIC2's needs.

COLUMNS

MATERIAL: The **structural columns** are made from new **Pinus pinaster** wood (Sourced from the Landes forest). An affordable material and not very resistant as a single component, the material is structurally efficient in assemblies. The use of a 6.5 m length of the wooden elements reduced the need for mechanical joints.

GROUND FLOOR WOODEN SLAB

MATERIAL: The structural timber is made of **Douglas and Scandinavian red pine**. The essences are not local but have the advantage of their length (5,5m). The wood had been pre-cut, planed and treated by the reseller.

RECLAIMED MATERIAL: The project uses 30% of reclaimed wooden battens with different sections and profiles, subject to deformation. It required in situ adaptation of connections.

MATERIAL: Wood Wool Insulation was obtained using industrial waste from wood production. Two types of wood fibre insulation panels were used: one contains short and dusty fibres, the other very long ones. The panels can be cut and will be reused.

MATERIAL: The Oriented Strand Boards (OSB)

SYSTEM: The metal roof covering

The dry mechanical connections used for fixing make the (dis)assembly of the roof very easy. Due to their large dimensions, the metal sheets allow a fast and efficient covering. However, specialised tools are required to properly install the roof covering; this should be identified and defined in detail at an early design stage.

SYSTEM: The structural beams

are adaptable and were designed to adjust both to a pitched roof and to a flat one. The beam can be easily assembled and disassembled with screws. OSB boards provide the support for the wood fibre insulation panels.

SYSTEM: The bi-directional columns

involve the assembly of four single wooden profiles (60x60mm). At 120cm-intervals a cross-insert is foreseen to prevent structural deformation. The modularity increases the adaptability of the system.

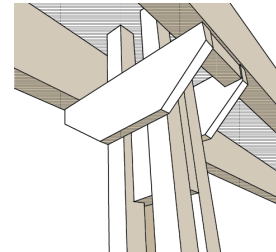

CONNECTIONS BETWEEN ROOFS:

A double beam ensures the transition between the flat and the pitched roof.

UPGRADABILITY OF THE BEAMS:

Splice joints of several elements were necessary to cover the span.

OSB BOARDS are screwed or clamped between the rafters. To avoid damage from disassembly, the boards are square edged.

CONNECTION BETWEEN COLUMNS AND THE ROOF BEAM:

the beam is slid through the four wooden profiles of the vertical columns and lays on the cross insert.

UPGRADABILITY OF THE COLUMNS:

To attain the necessary height, the four wooden profiles are expanded by screwed joints (see Figure 27)

CONNECTION AND UPGRADABILITY

The mechanical joints, such as metallic timber hangers, screws, and bolted connections, are providing simple disassembly options. Other dry wooden joints are used such as the lap, mortise and tenon, cross lap, splice joint, tongue and groove.

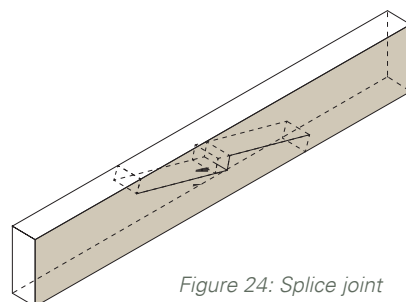

Figure 24: Splice joint

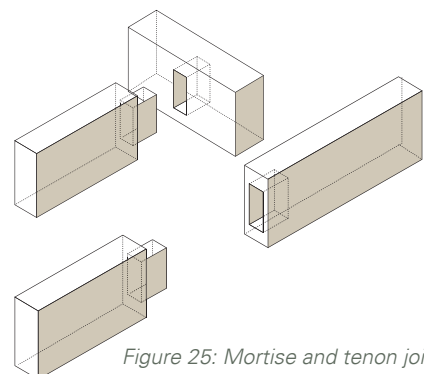

Figure 25: Mortise and tenon joint

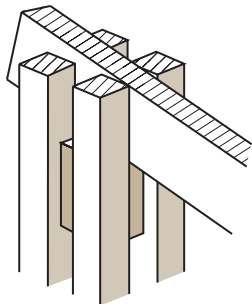

Figure 26: Connection of the roof structure



Figure 27: The columns were constructed during the EFP workshop in the winter 2018

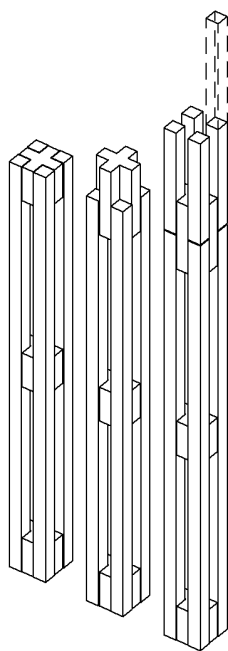
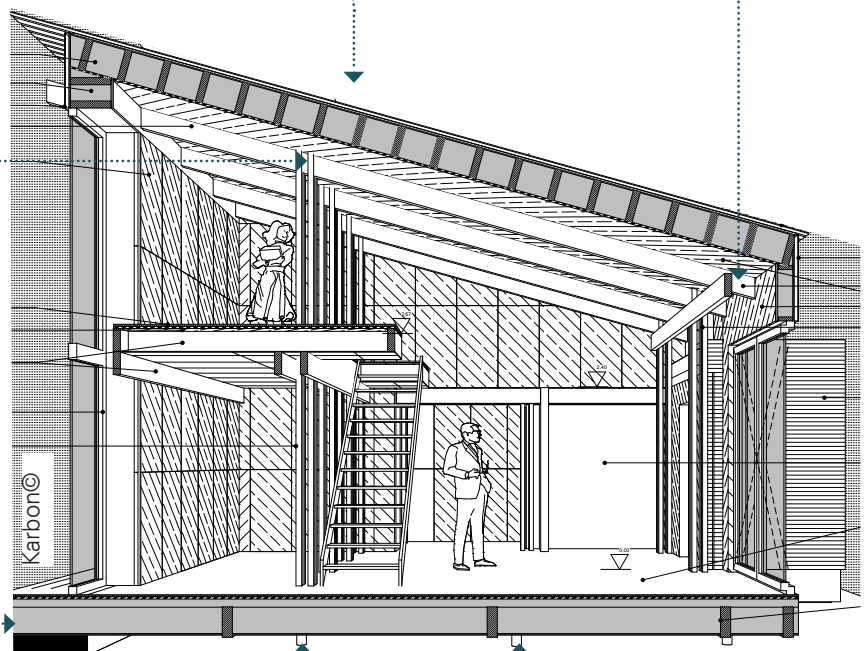

Figure 28: Columns and the circular features



MATERIAL: The screwed foundations are made from **galvanised steel**. The combination of zinc and galvanised steel provides the necessary material resistance to later remove the elements without damaging them.

SYSTEM: The **screw-based foundations** are adapted to the physical conditions of the site – the loose ground, the slope and spatial constraints – while offering a fully reversible solution. The helical fin allows the screw piles to be readily wound into the ground. Their removal is efficient, without waste and limited impact on the ground: no excavation and soil removal is needed. In practice, these screwable foundations are generally used by temporary and seasonal constructions at the seaside.

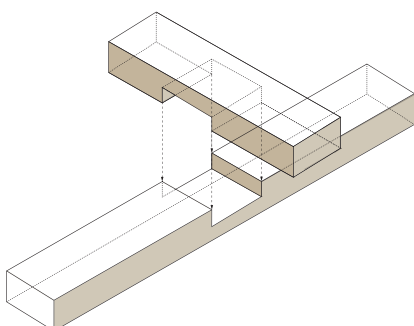

Figure 29: Cross lap joint



Figure 30: Screwable pile with connections

BRIC 1 BUILD REVERSIBLE IN CONCEPTION

FACADE COMPOSITION

ROCKPANEL is a new material issued from recycled materials: a combination of compressed natural basalt with 30% of rockwool residue.

The finishing of the facade (Rockpanel/ceddar wood lathing) is applied on wooden battens with mechanical fixation (screws).

The panels can be cut and assembled several times (Figure 35).

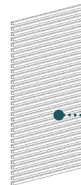

CONNECTION Screws and demountable wooden battens mechanically fix the facade cladding panels on the Insulated Timber Wall Construction.



CEDARWOOD LATHING was recovered from a previous EFP building. The wood presents good characteristics; it is light and rot proof.

TIMBER WALL CONSTRUCTION

MDF Boards are vapor-permeable fibreboards (MDF), on which the facade finishing is fixed.

SYSTEM The facade is composed of 117 interchangeable, self-supporting wooden **insulated cassettes**. This modular system allows different configurations of the building and the facades and integrates reflections for the next BRIC project from the beginning. The Insulated Timber Wall Construction is easily assembled and disassembled thanks to the geometry of the edges. The dimensions of the raw material (OSB panels) and no-waste strategy dictate the realisation of 40cm wide boxes. This is a constraint for the building, which required slightly bigger dimensions (45cm), in order to become a passive building.

The zero formaldehyde Oriented Strand Boards (OSB) are made from wood industrial production waste. This material is still formaldehyde free. The panel has a strong reversible, reusable and adaptable capacity; it can easily be cut and reused.

Cellulose is a recycled paper-based insulation material, insuflated into the facade boxes. BRIC1 uses new material.

OSB zero formaldehyde Board

The I-joist beam is a structural wooden beam which carries heavy loads while efficiently using materials. The Insulated Timber Wall Construction uses a new I-Joist structure, as it is difficult to guaranty the stability of reclaimed ones.

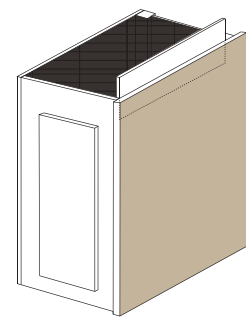

Figure 31: Insulated timber wall construction

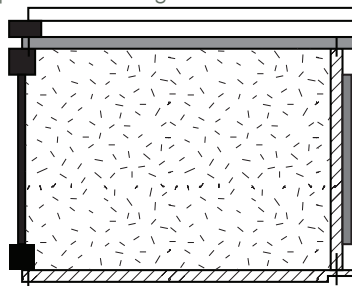

Figure 32: Insulated cassette

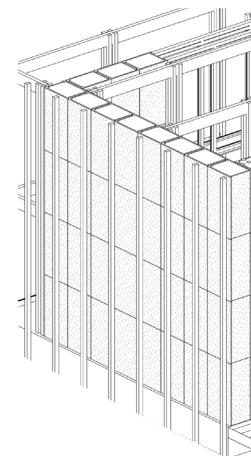

Figure 33: Timber wall construction



Figure 34: The insulated cassettes for the facade system were realised in the EFP workshop during the winter 2018

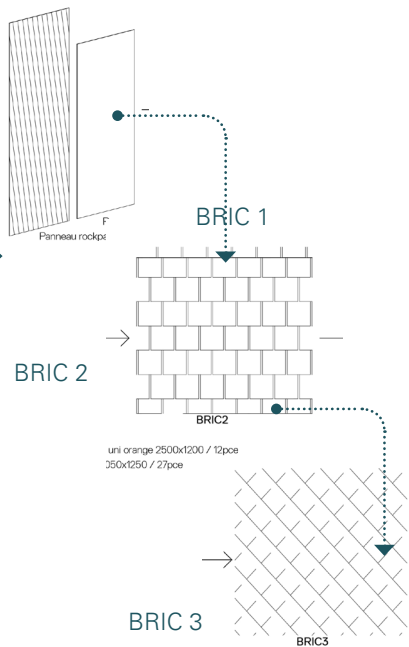

Figure 35: Transformation for the rockpanels

FINISHING

MUD BRICKS: The partition walls were made of mud bricks. Less energy and carbon intensive than in the case of traditional bricks, the production of mud bricks creates minimum waste. The bricks' density and qualities increase the building's thermal inertia, its acoustic performance, and its hygrometric autoregulation capacity. The material is highly resistant in an indoor environment.

REED: Reed is a water plant that has been used for centuries in the construction industry. The material has high insulation qualities.

CLAY-BASED PLASTER: The interior walls use clay-based finishing

SYSTEM: MUD BRICKS WALL The assembly of mud bricks allows different partition wall configurations, thus increasing the spatial flexibility of the floorplan.

SYSTEM: PLASTER ON REED MAT Three layers of clay plaster were applied on a reed mat screwed on the wall. The reed mat allows the plaster to be evenly applied. The system will be partially recovered for BRIC 2. The clay will be reused as a first base layer for finishing. The final thin plaster coating will be made with new clay plaster.

SERVICES

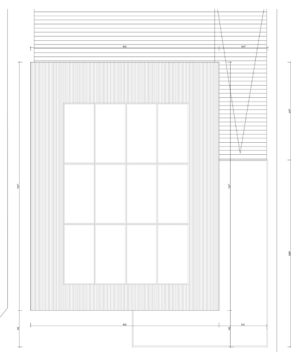

HOT WATER: Twelve new solar photovoltaic panels and the power inverter were reclaimed from the surplus from another construction site.

HEATING: The air-to-air heat pump has the capacity to respond to the future BRIC projects' needs. The air is diffused through ventilation ducts which are micro-perforated. The ducts are interlocked and clipped, and not welded.

ELECTRO-TECHNICAL SYSTEM is managed with home automation and this enables the assembly and disassembly of the entire network.

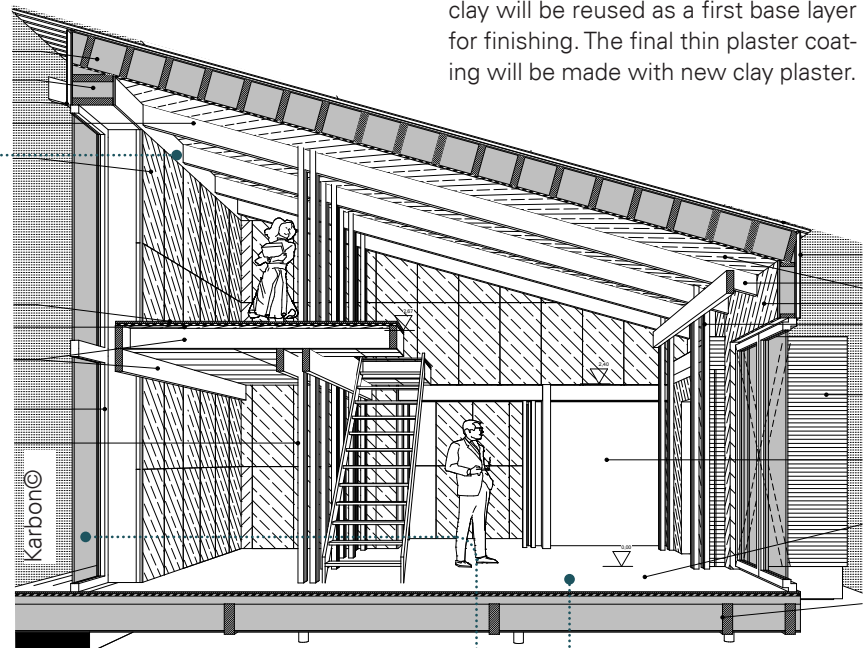

GLASS: Glass has a large environmental footprint, due to both its production and recycling processes. Thus, exploiting its reuse potential is one of the goals of the BRIC project. The dimensional constraints have an impact on the design of the second and the third building's architecture.

WOOD: The use of wood is maximised for all finishing layers.

WINDOWS: Frames: Two out of four wooden window frames are reused.

FLOORING: The project uses tongue and groove hardwood boards that are not glued. The boards are laying on an acoustic panel.

BRIC 1 BUILD REVERSIBLE IN CONCEPTION

4.4.2. ASSEMBLY



The BRIC project uses 32 piles, each 1,2m in length and with a bearing capacity of 3t. Foundations are conceived to bear the load and adapt to the shape of the future transformations. The installation was easier, faster and cheaper than for a concrete foundation solution. The piles will be reused at the end of the project, after 2020.



The worksite highlighted the need for perfect alignment, necessary for the correct placement of the ground floor wooden slab. The capacity of the connections to cope with the natural slope of the ground should be pre-tested.



The four load-bearing beams supporting the bi-directional ground floor wooden slab are providing an upgradable and reusable system pre-designed to withstand the load of an extra floor. The adaptability is provided by dry joints and the absence of nails and glue, although this requires extra construction time.



The reliability of new products resided in their standardisation. Reclaimed materials need an adaptation of the joints and dimensions at the worksite because mechanical fixations (e.g., hangers) are often not compatible with the reclaimed wood's dimensions. The worksite revealed the need for an organised upfront supply system of reclaimed materials.



Once mounted, the structure was filled with cork granules and covered with flexible wood wool mats.



The wooden slab will remain in place during the three successive versions of the building: BRIC 1, BRIC2, and BRIC 3. The dimensions of the slab will be adjusted to each version. At the end of the project, all the materials will be recovered and re-used.

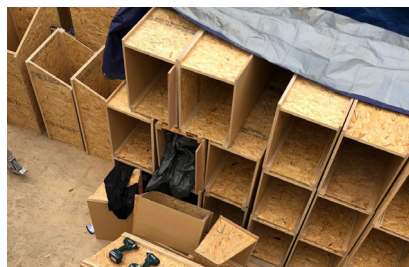

The insulated timber wall construction was realised in the EFP workshop during winter 2018. The system does not use screws for its fixation. Assembly and disassembly were realised using joints integrated into the edge geometry.

Building the external walls required a very precise installation to ensure the stability and an effective airtightness. The weather factor plays an important role: Insulated Timber Wall Construction are difficult to place and fill with insulation in case of high humidity.

The project highlighted the need for an interactive relationship with the manufacturer, to adapt dimensions of existing products and find materials adapted to the needs of the project.

Thanks to the modular construction, no waste was generated on the worksite and only limited waste for the making of the boxes. All the cassettes will be reused for future BRIC projects, except boxes used at the level of the pitched roof.

Thirty-six wooden profiles were used for the nine columns. The worksite highlighted the fragility of the material (single profile), the importance of good storage conditions, and the care needed for the installation of visible material. The use of this system shows the material's flexibility and reuse potential. It highlights the capacity of the system to bear the load in two directions and the advantages of standardised measures. The height is increased by mechanical joints. Although the use of such columns takes longer than that of classical solid wood beams, assembling and disassembling the system is fast and uses less material. The pre-treatment is adding extra costs which are easily recovered thanks to the faster execution.

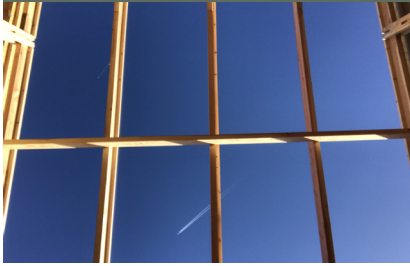

The installation of the roof structure required pre-tests in the EFP workshop. The system is independent: some columns were mounted after the roof structure. Weather was a constraint for stock availability and humidity conditions which are very important for material integrity.



The initial roof design foresaw an insulated cassette system. The carpenters team later chose a simpler and efficient solution requiring less material. The classical solution of inserting wooden wool panels supported by OSB boards between the rafters is lighter and lowered structural risk.



Cellulose had been blown into the wall boxes to insulate BRIC 1. Initially, the conception team proposed the injection of used cellulose. The contractor was not comfortable with the risk posed by reclaimed material. Untraced material might present impurities and damage the insufflation machine.



The sheets of galvanised steel covering the roof were purchased through a digital re-use platform for building materials. They were perforated to be able to screw them on the roof counter battens of BRIC1.



The photovoltaic panels were screwed on the roof on aluminium rails.



One of the difficulties encountered on the building site was achieving airtightness of the reclaimed windows and doors. The quality of the joints had to be checked and adapted to the high energy performance design criteria.



The compressed mineral wool mats are installed on wooden battens.

The cedar wood facade was installed and screwed on wooden battens.



Despite its reuse potential, the difficulty of using cedar wood was linked to operational issues. It was difficult to assess available quantities directly (dimensions). The quality of the material after disassembly was not known (as former connectors have damaged the material). This situation highlighted the need for connectors that are readily removable using simple tools.

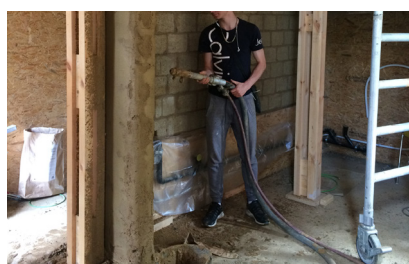

For future projects, it will be possible to re-adapt and cut the material into smaller pieces.



In order to reduce waste generation, a very detailed laying plan is necessary. The support needs to be perfectly straight to avoid the deformation of materials and therefore increase their reuse potential.



Cutting creates a lot of dust and could damage the machines. These aspects must be considered during the conception phase.

The walls were finished with ochre and red clay. The reed mat allows the clay plaster to be evenly applied.



BRIC 1 BUILD REVERSIBLE IN CONCEPTION

4.4.3. DISASSEMBLY

18 DAYS BETWEEN THE 15.10.2018 & 24.11.2018



ELECTRICAL SYSTEMS

The disassembly started with the electrical services: electric outlets, boxes, and cables. The lighting system was recovered after its removal from the ceiling. All materials were retrieved. No waste was created as 100% of the material will be reused.

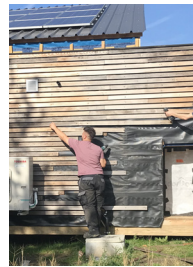

FACADE CLADDING

The boards were unscrewed. Screws were recovered and panels were labeled with a code bar. Wooden cedar battens and supports were organized by length.

INTERIOR FINISHING

100% of the floor finishing was recovered. The plaster applied on the adobe or OSB was removed. The painters broke the plaster with a wooden mallet, then unscrewed the reed mats. The clay was recovered and stored in bags. The support membranes of the plaster (reed cane and linen fabric) are not reusable. They were broken and/or torn apart. This loss was predictable. These membranes are bio-sourced and compostable materials. Disassembly was easy but created a lot of dust. The mud bricks were removed using a wooden mallet. The clay joints were recovered and the bricks were stored on wooden pallets.



ENVELOPE

The removal of the cellulose insulation by suction required making new holes in the wooden boxes.

The windows, frames, and studs, were extracted from the facades, without trace or damage. The disassembly was difficult due to the dimensions and the deformations of the wood.



The team put in place an internal Material Passport system, including a logistics system, an inventory, a link between physical materials and the digital data- base. This was necessary for tracing materials and made the BRIC1 disassembly easier.

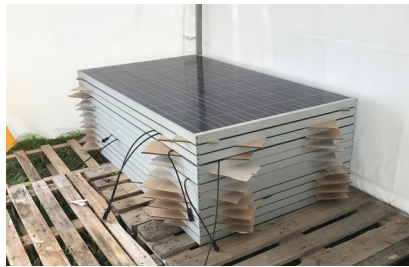

SPECIAL TECHNIQUES (solar panels and heat pump). The heat transfer fluid was recovered. The air ducts, and solar panels were disassembled and stored. The photovoltaic panels are fragile and require extra care.



ROOF COVERING
Metal sheets were unscrewed and easily handled. The flexible insulation fibreboards were removed and carefully stored. The material is fragile. The dismantling encountered minimal losses.



SUPERSTRUCTURE
The dismantling of the roof structure and the walls: First, the column and the roof beams were disassembled. It was followed by the disassembly of the insulation boxes without any damage. Screws were recovered but a large number of heads were damaged.



The central column suffered deformations. All the airtightness and waterproof membranes were removed but constitute waste as they will not be reused.



WASTE: Tailor-made pieces, twisted screws, airtightness, membranes are creating little waste. Waste is evaluated at only 3,5 m³.

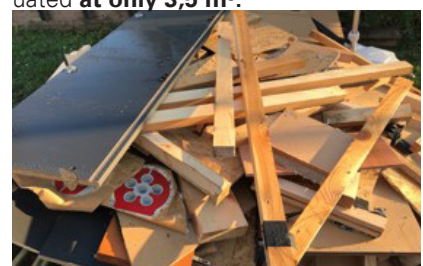

BRIC 2 BUILD REVERSIBLE IN CONCEPTION

4.4.4. ASSUMPTIONS OF THE TRANSFORMATION

Ground Floor
53.7 m²



Not demounted, 30% re-claimed material (Timber Joist)

Timber Frame



Recovered 100% in BRIC 1

Mezzanine
12.7 m²



Recovered 100% for BRIC2

Pitched Roof
45.5 m²



Wood wool
On BRIC1: 75% reused 25% of wood wool residues. When disassembling, the wool pane crumbled (2 types of wood STEICO used wool fiber, one is very short and dusty, the other very long).
Waterproof Membrane not reusable
OSB
BRIC1 100% reused for the three re-constructions

Pitched Roof Roof covering
45.5 m²



Recovered 100%

Flat Roof
13.7 m²



EPDM
Recovered 100%. BRIC2 has a flat roof and so new EPDM will be purchased.

External Wall Type 1B
Clay Plaster Finish
31.1 m²



The support membranes of the plaster (reed cane and linen fabric) are not reusable. They were broken and / or torn apart. Membranes are fragile elements. This loss was predictable. These membranes are bio-sourced and compostable materials.

External Wall Type 2
31.1 m²



Ceddar cladding

Cedar Cladding
100% reused in BRIC2

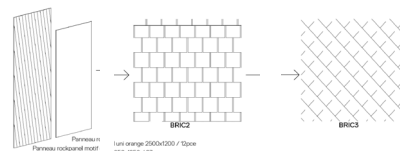
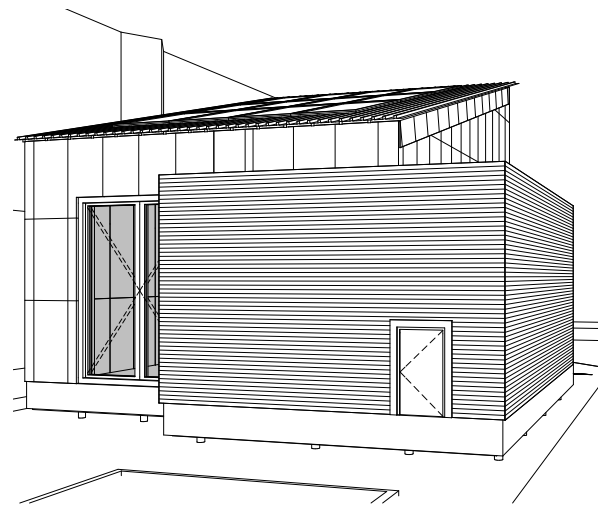

Figure 37: BRIC 1

External Wall Type 1A
60.2 m²



Compressed Mineral Wool Panel

10% of the panels are considered as non-usable, to not be used/reinstalled on the facade. The rest will be installed in BRIC2

Batten
100% reused

Wall constructions (caissons)

30% of the wall constructions will not be re-installed in BRIC2 (25 non-standardised wall constructions cassettes, adapted to the slope of the slanted roof). Panels are not considered waste, they are kept.

Cellulose

95% reused
5% of the cellulose residues were not recovered (via vacuum cleaner). These flakes in the form of dust are volatile.

External Wall Type 1B
31.1 m²



Compressed Mineral Wool Panel

10% of the panels are considered as non-usable, to not be used/reinstalled on the facade. The rest will be installed in BRIC2

Batten
100% reused

Wall constructions (caissons)

30% of the wall constructions will not be re-installed in BRIC2 (25 non-standardised wall constructions cassettes, adapted to the slope of the slanted roof). Panels are not considered waste, they are kept.

Cellulose

95% reused
5% of the cellulose residues were not recovered (via vacuum cleaner). These flakes in the form of dust are volatile.

Windows Frame



50% of the chassis are in bad condition. This rate concerns the installed chassis being reused.

Windows Double Glazed Unit



Recovered 100%



Procured as new products



Reclaimed material

Ground Floor 53.7 m² 100% reused from BRIC1



Timber Frame



Mezzanine 12.7 m²



Wood block floor
60% procured as new
40% reused from BRIC1
Compressed Mineral Wool Panel Ceiling
60% procure as new
40% reused from BRIC1
All the rest Materials
Procured as new products

Pitched Roof 45.5 m² N.A.

Flat Roof 13.7 m²



External Wall Type 1B
Clay Plaster Finish
31.1 m²

Procured as new products



External Wall Type 2
31.1 m²

Cedar Cladding
40% Procured as Reclaimed (not from BRIC1).
60% Reclaimed from BRIC 1
All remaining Materials
5% procured as new
95% reused from BRIC1

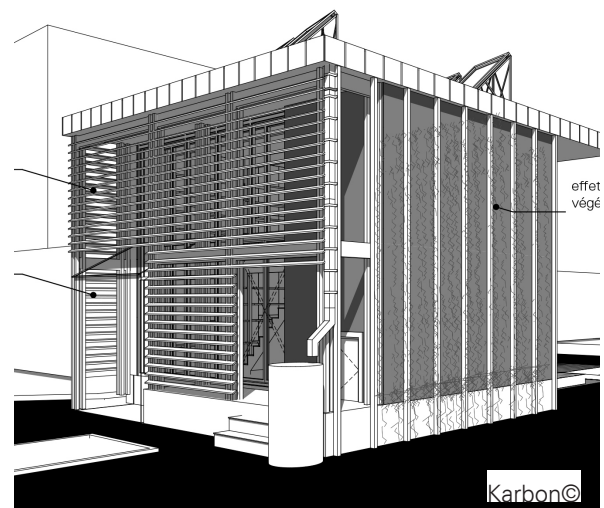

Figure 38: BRIC 2

External Wall Type 1A
60.2 m²



Compressed Mineral Wool Panel
100% Reused from BRIC1
Batten
100% reused
Wall constructions (caissons)
100% reused
Cellulose
100% reused

External Wall Type 1B
31.1 m²



Compressed Mineral Wool Panel
6 m² procured as new
28 m² Reused from BRIC1
Batten
100% reused
Wall constructions (caissons)
22 m² (66%) Reused from BRIC1
12 m² (34%) procured as new = 19 new wooden cassettes
Cellulose
90% reused from BRIC 1
10% procured as new

Windows Frame



Partially re-used from BRIC 1, Not evaluated yet

Windows Double Glazed Unit



Partially re-used from BRIC 1, Not evaluated yet

Façade Shading

BRIC 2 BUILD REVERSIBLE IN CONCEPTION

4.4.5. PREPARATION OF THE TRANSFORMATION

CHANGES FROM BRIC 1 to BRIC 2

During the preparation of the BRIC 2 worksite, in February 2019, the major changes foreseen by the architects were related to the wooden columns. Due to deformations that occurred in BRIC1 and the future construction of an extra floor in BRIC2, the columns were disassembled and reinforced.

The inserts initially placed every 1,2m along the wooden profiles were spaced more closely in BRIC 2, every 0,55m. The section of the column was also adjusted from 13,3x17cm in BRIC1 to a more stable profile of 17x17cm in BRIC2 as illustrated below.

The floor was used to secure the structure. Two stacked columns were assembled by using the first floor as an intermediary element.

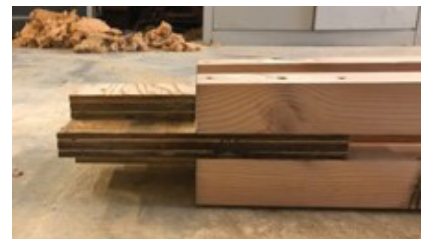
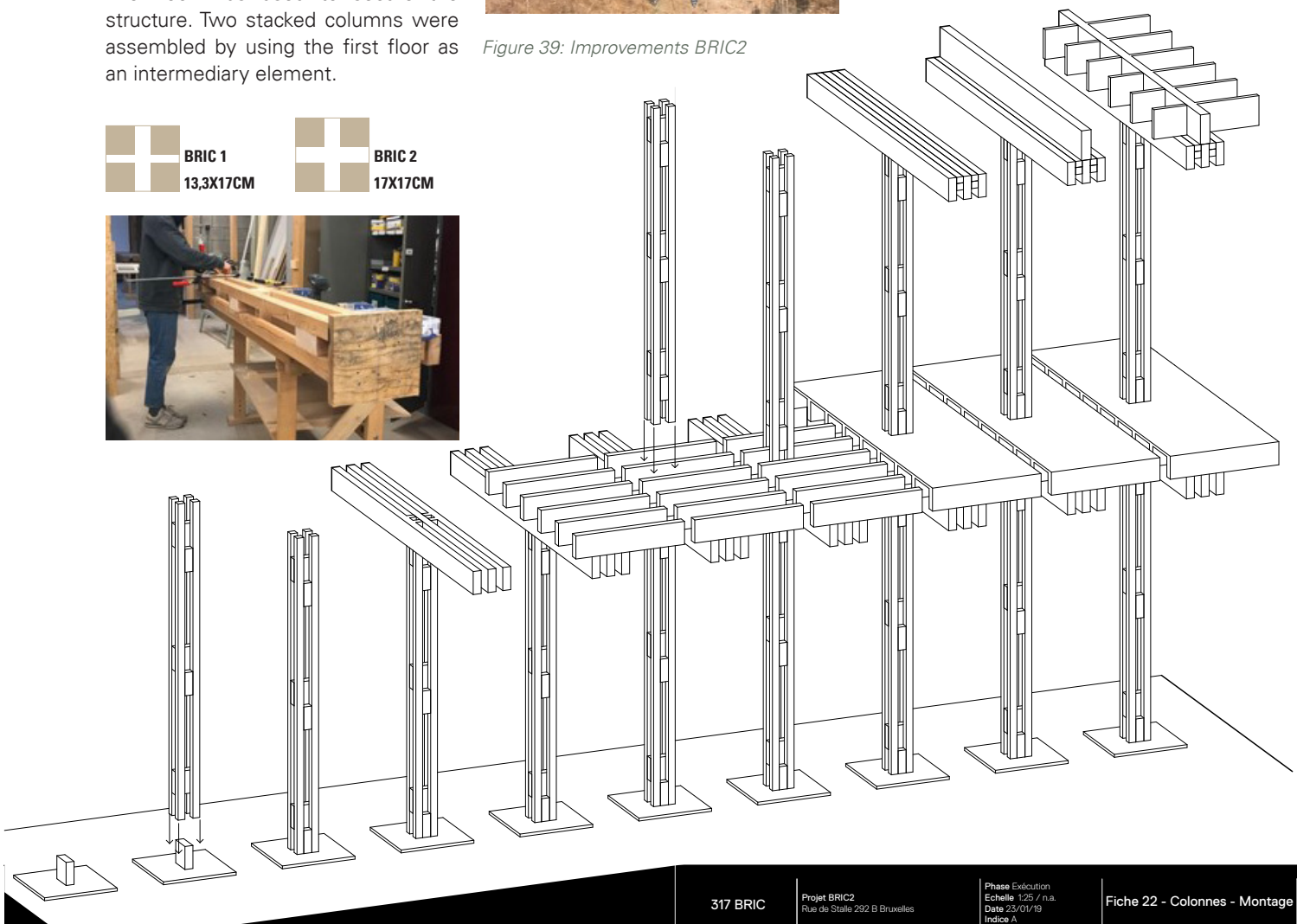

Figure 39: Improvements BRIC2



317 BRIC

Projet BRIC2
Rue de Stalle 292 B Bruxelles

Phase Exécution
Echelle 1/25 / n.a.
Date 23/01/19
Indice A

Fiche 22 - Colonnes - Montage

N° Dessin
22



Figure 40: BRIC2 Model



GTBL

4.5. GREEN TRANSFORMABLE BUILDING LAB

4.5.1. DESIGN APPROACH

GTB LAB AN INTERACTIVE TOOL

The GTB Lab has tested indicators of the Reversible Building Design tools during its development phase. Indeed the GTB Lab module was assessed in order to verify the criteria used to calculate the reuse potential of the building elements. In addition the assessment helped improve some points in the design of the GTB lab pilot in order to increase the reuse potential of its components.

REVERSABILITY

The **GTB LAB CIRCULAR MODULE** achieves full reversibility and high reuse potential of all its building parts.

Four strategies were investigated and applied.

REVERSIBILITY AT MODULE LEVEL

Constructive systems of the module can play different roles as facades, roofs and floors. For example, the wooden facade structure was used to create a floor/terrace during the transformation of the module, extending its useful surface.

REVERSIBILITY AT COMPONENT LEVEL

Individual components can be reconfigured for instance within a facade transforming a door into a window or a shelf.

DESIGN - PRODUCTION MEASUREMENT

Coordination between the design and production of elements cuts waste generation by 98%.

REPLICABILITY

The standardisation and the ease of assembly-disassembly facilitate replication. Moreover, the 3D-module can be transported and extended easily.

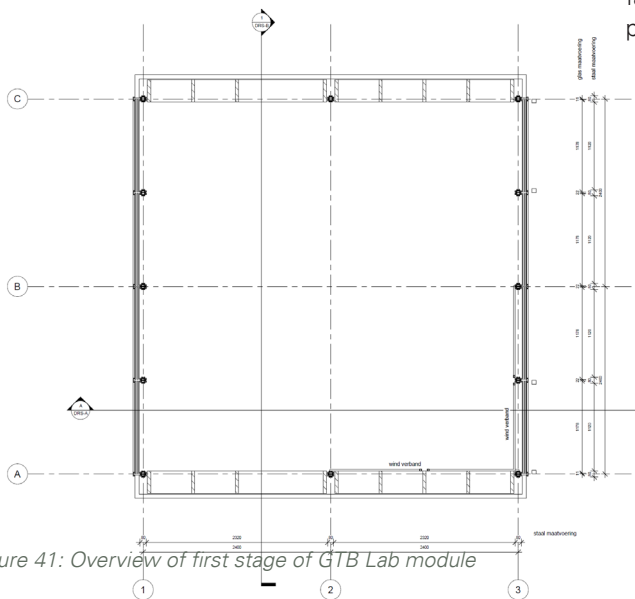
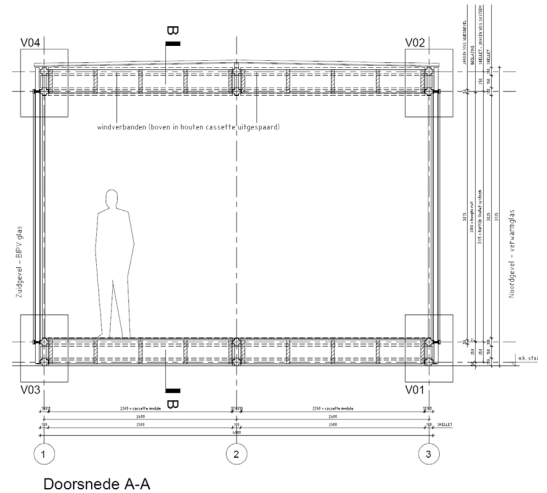

Figure 41: Overview of first stage of GTB Lab module



Doorsnede A-A

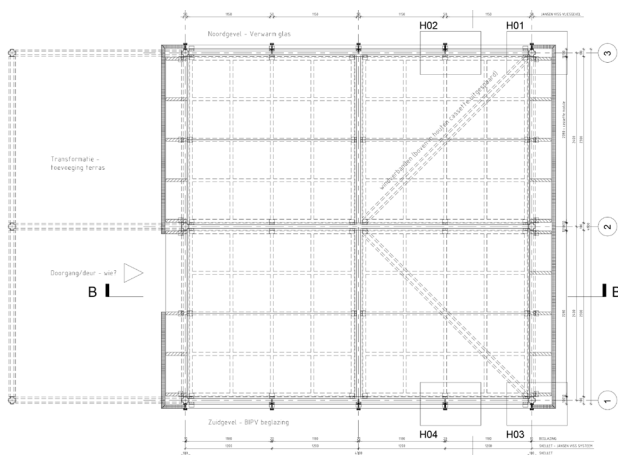
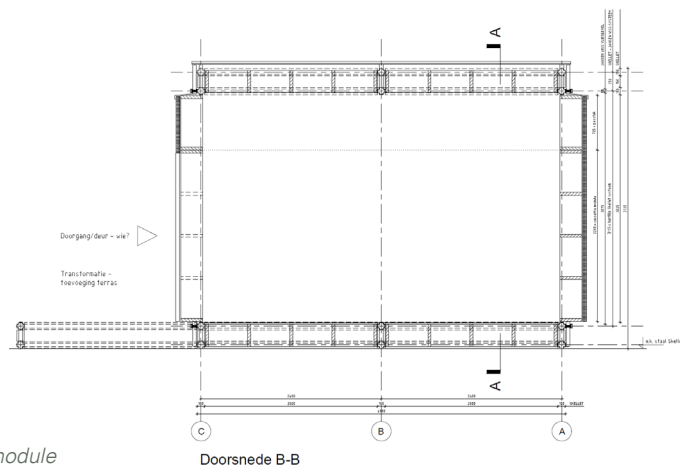

Figure 42: Floor plan and section of the transformation of GTB Lab module



Doorsnede B-B

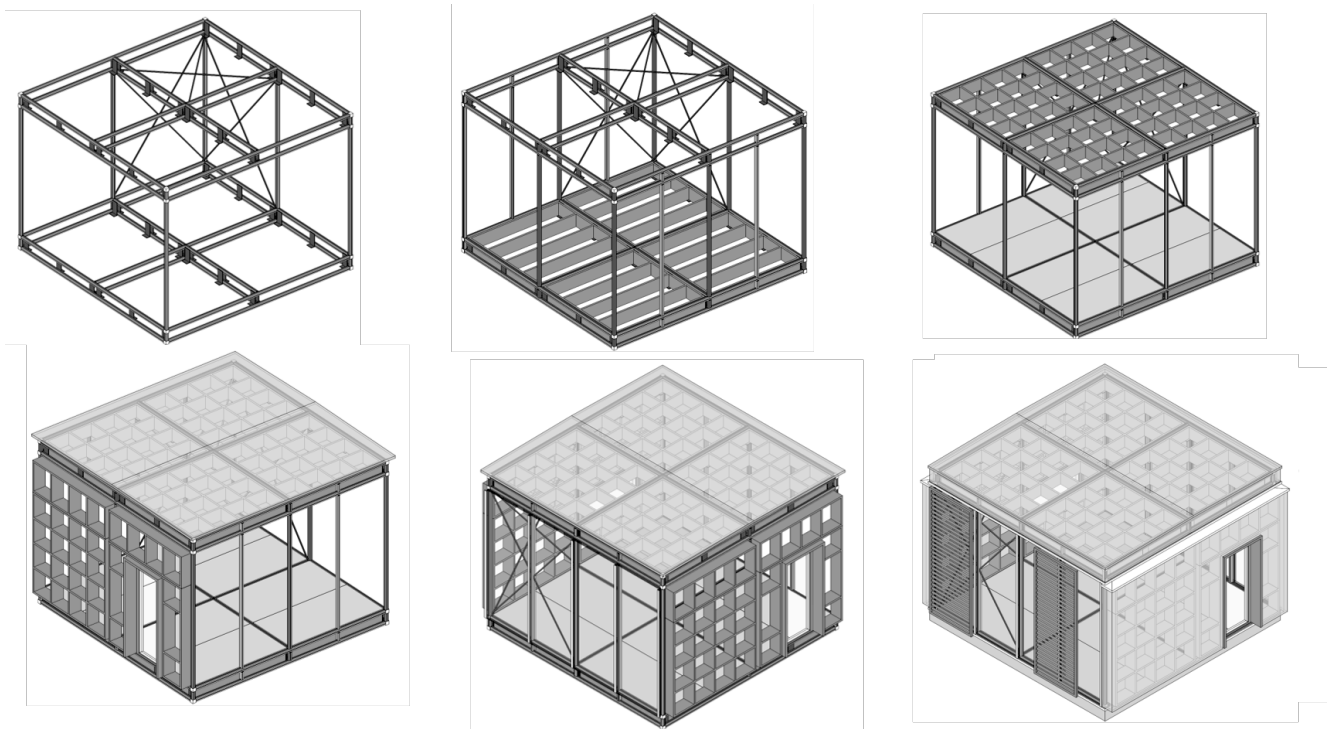

Figure 43: Overview of assembly sequences of GTB Lab Module

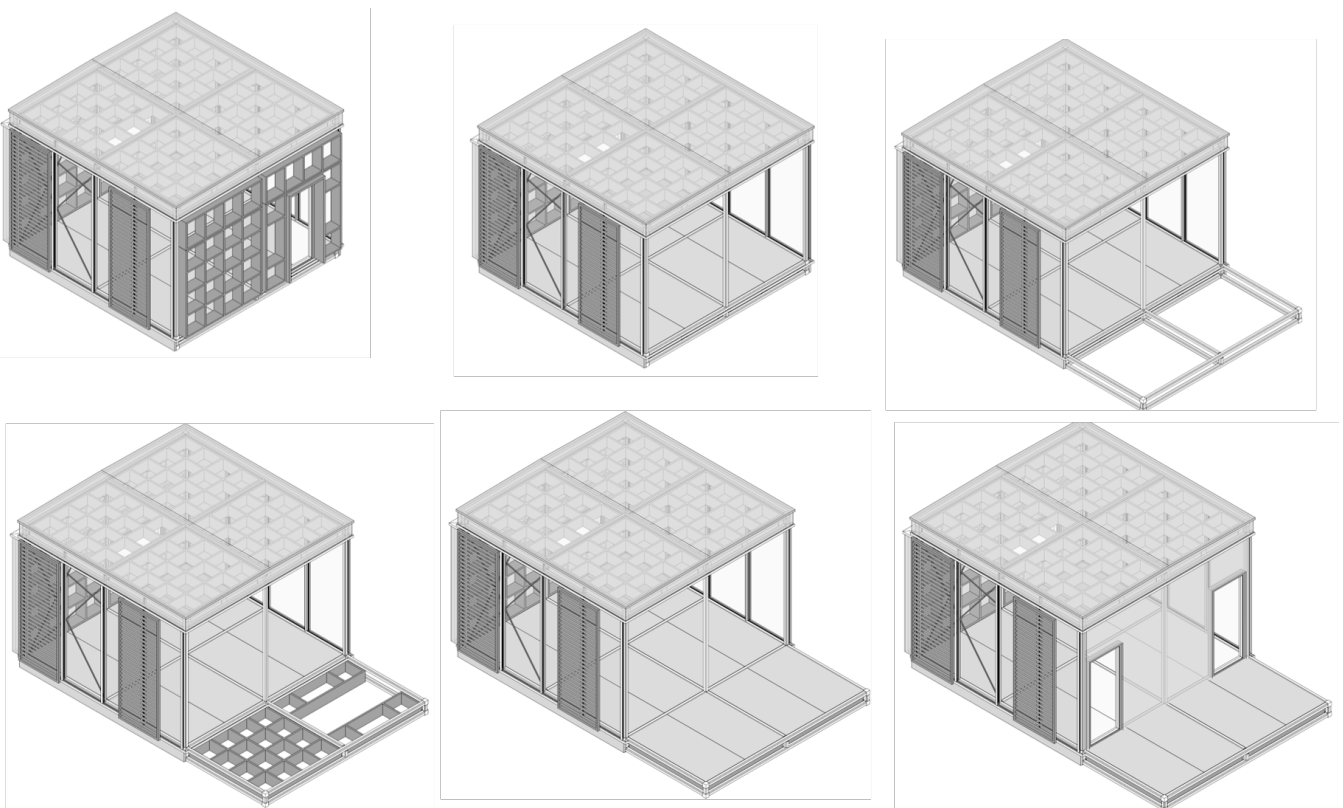

Figure 44: Overview of the transformation sequences of GTB Lab Module

GTBL GREEN TRANSFORMABLE BUILDING LAB

SPECIFICATIONS OF MATERIALS, TECHNICAL SPECIFICATIONS AND DETAILS ABOUT THE COMPONENTS



Figure 45: Prototyping phase

STRUCTURE

MATERIAL: Steel profile: The capacity of the metal to be reused, to bear extra loads, made it a perfect candidate for an upgradable module. Sequential reuse counters the environmental impact of the production and recycling processes. Steel is easily accessible and enables assembly/dis-assembly without being damaged or creating waste.

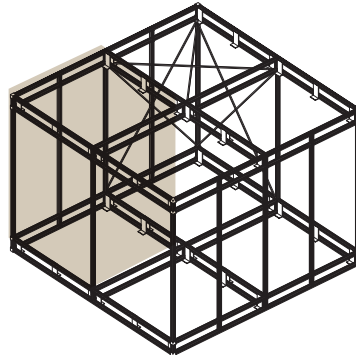

SYSTEM: The steel frame

A frame was designed to support reversibility of all connected components.

A standardised modular grid 240x240cm enables exchangeability of roof, facade and floor panels; The standard dimensions of the frame allow the substitution and replacement of components applied on the floor, facades, and roof. The modular system is made as such to demonstrate its reversibility and extendibility. The geometry of the steel profile has been tested during the prototyping phase.



Physical interfaces decomposition

The prefabricated geometry of the profiles makes it possible to connect all components without damaging them. The **product edge** allows the reconfiguration of the system.

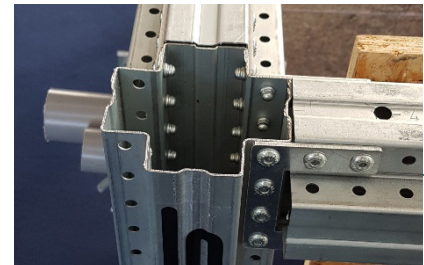

Standardised intermediary: The prefabricated tri-directional geometry binds together, in a reversible way, the metal structure and the facade elements and systems.



Figure 46: source Metsawood

MATERIAL: Kerto® Wood is a laminated veneer lumber product. This material allows the construction of standardised reversible wooden cassettes which can be applied as floor, roof or facade components

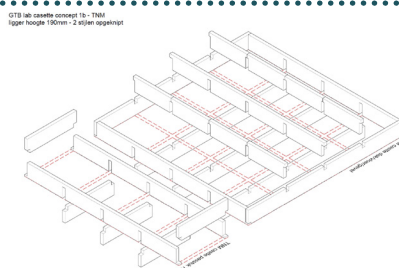

SYSTEM: Wooden slab, the modular facade, roof: Using prefabricated geometry and universal connections the reversible wooden envelope can serve as floor, roof, or ground slab.



Standardised connections: Locking half blind Dado joints allow the modularity of the wooden structure.



Standardised connections: Metal connections are fixing the wood on the intermediary metal elements.



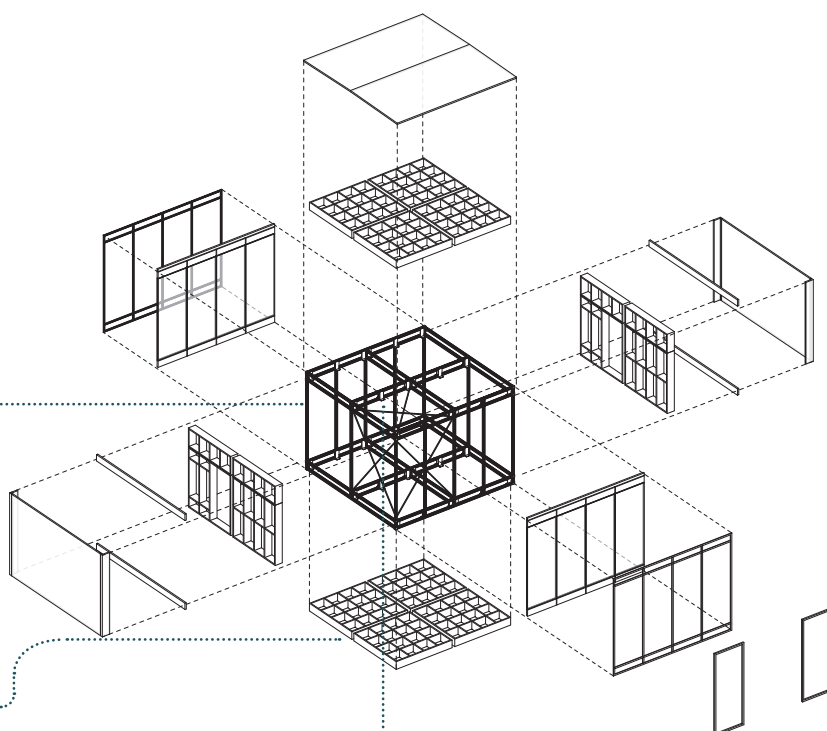
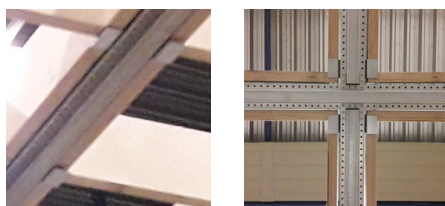

Figure 47: Overview of reversible GTB Lab module system composition

GTB Lab module has been developed around a reversible multifunctional steel frame which was filled by independent, exchangeable, standardised and reversible floor, facade and roof components.

Standardise connections: gravitational supports



1. REVERSIBLE STRATEGIES

Material selection for the GTB Lab demonstrates the reversibility options for different materials and building functions. Materials need to allow the upgrading of the building, while meeting the energy efficiency standards.

The steel frame is **the core of the reversible structure**. Its design enables multiple transformation options at module level

Standardised intermediaries between different systems secure the connections between systems, floor, roof, facades and the core of the module relying only on one standardised connection and gravity.

Functional decomposition enables independent transformations and upgrading of different elements (clusters), such as the facade system that can be switched and transformed.

Reversibility at different levels

INDEPENDENCE:

At the module level, the facade can be transformed into other functional systems: ground slab, etc.

EXCHANGEABILITY

Due to the modular structure, at the element level, different configurations can be achieved;

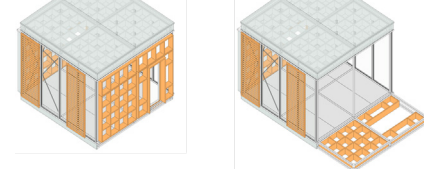

for example the openings in the facade are exchangeable.

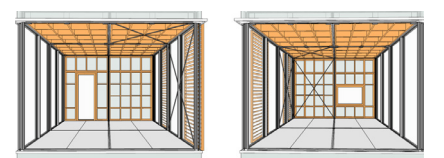

GTBL GREEN TRANSFORMABLE BUILDING LAB

SPECIFICATIONS OF MATERIALS, TECHNICAL SPECIFICATIONS AND DETAILS ABOUT THE COMPONENTS



FACADES

Triple solar glass: The south facade uses energy producing glass.



SYSTEM: glass facades: The PV strips placed on the glass maintain an equilibrium between shading and light.

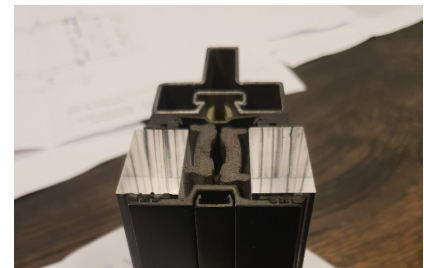

Intermediary based on interlock connection allows different subsystems to be independently assembled and disassembled by locking an element with two connecting parts.



FACADES

MATERIAL Triple solar glass: This special technology (applied by Pilkington) is used for the northern facade. The glass has built-in thermal heat technology and is being heated during the winter.



SYSTEM: This warm and transparent facade is preventing the cold air to penetrate the interior space, while limiting the heat transfer outside.

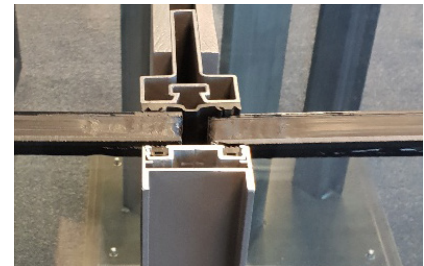

Intermediary based on interlock connection takes care that different subsystems can be independently assembled and disassembled by locking an element with two connecting parts.



FACADES:

MATERIAL: Polycarbonate: This polymer-based (processed) material is, resistant and translucent.



SYSTEM: This multi-layered facade panel with multiple air chambers provides the same amount of natural light within the space as normal glass would. The material is energy performant (0.83 W/m² K. To 2,45 W/m² K.) and can be further upgraded by adding air chambers within the panel or by creating a double facade.

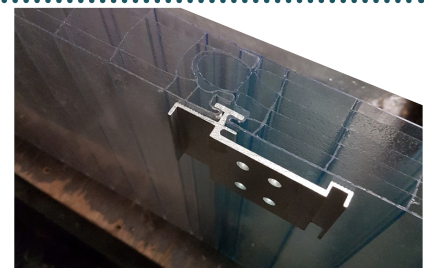

Interlock Geometry of product edge fixes two elements without harmful connecting devices..

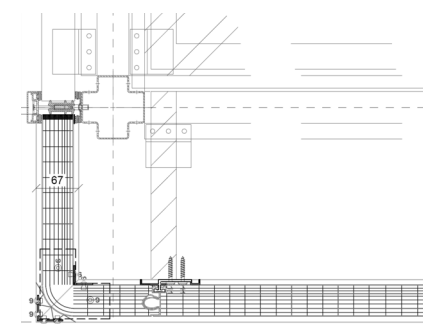

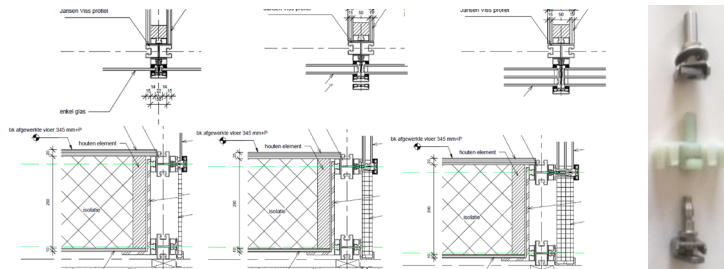

Figure 48: Adaptability: From single glazing to triple glazing, GTB Lab

REVERSIBLE STRATEGIES

Intermediary

Locking an element with two connecting parts

Upgradability

The glass facade can be upgraded from single glazing to triple glazing thanks to an upgradable connection type with an exchange connector in combination with the ability of the glass producer Pilkington to remanufacture single glass panels into double and triple panels.

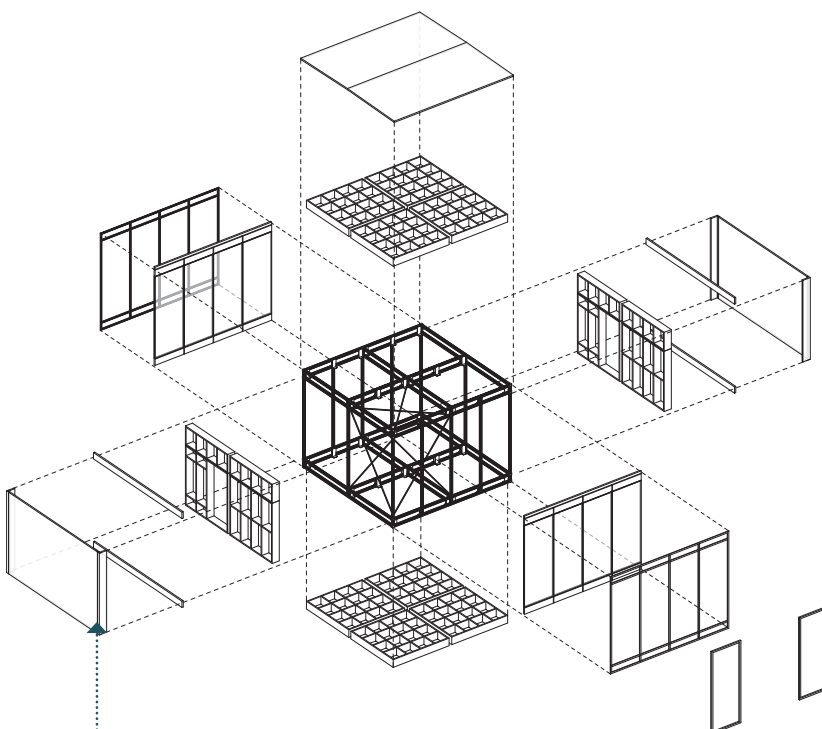
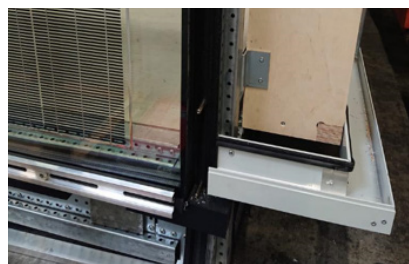

Figure 49: Overview of reversible GTB Lab module system composition

Interlock Connection, connexion supporting the polycarbonate frame



GTBL GREEN TRANSFORMABLE BUILDING LAB

4.5.2. ASSEMBLY

The production of the first GTB Lab reversible steel module started in November 2018 at the ODS work-place in Ridderkerk (NL).

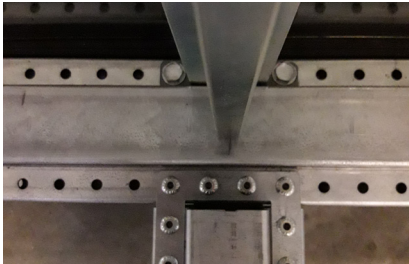

During the constructing and transformation process the industry partners have made production drawings and each partner was responsible for the assembly and transformation of its own product.

Architects oversaw the checking of the production drawings and arranging the assembly/transformation process with each partner. The GTB Lab module is fully made of a number of pre-assembled components which have been brought to the assembly site at Kloeckner ODS in Ridderkerk where the reversible GTB Lab module has been assembled. This required good preparation, production of all components at the partner's manufacturing sites and timely transport.

This also meant that no adjustments could be made during the construction/assembly and that all components and connections which were brought to the assembly site had to be complete and measurements correct. There were a few setbacks during such a highly modular process which had to do with mistakes that can happen during production of individual components or communication of dimensions or technical issues between the partners. Some examples are provide below.

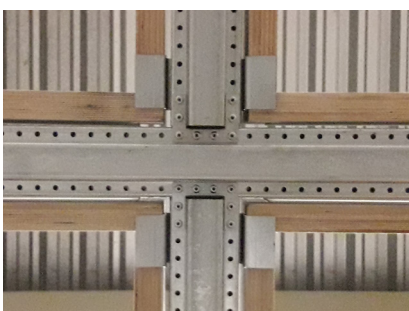



Reversible wooden roof cassettes were assembled within the metal frame of the GTB lab module. They were produced by the Delft based start-up: The NewMakers.



Three dimensions for Steel intermediary elements had been specified. In the first place, the industry produced only one dimension. In order to avoid waste by producing all new connectors a decision was taken to add an additional wooden intermediary under the floor cassettes and use already manufactured elements as much as possible to connect the steel frame with the roof, floor and facades.

The GTB Lab module applied for the first time triple solar facade elements (Pilkington Netherland) by inserting two additional components between glass elements and creating a facade component.

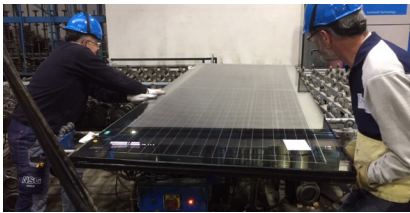

Assembling reversible triple glass panels with PV strips produced by Pilkington in Enschede NL.

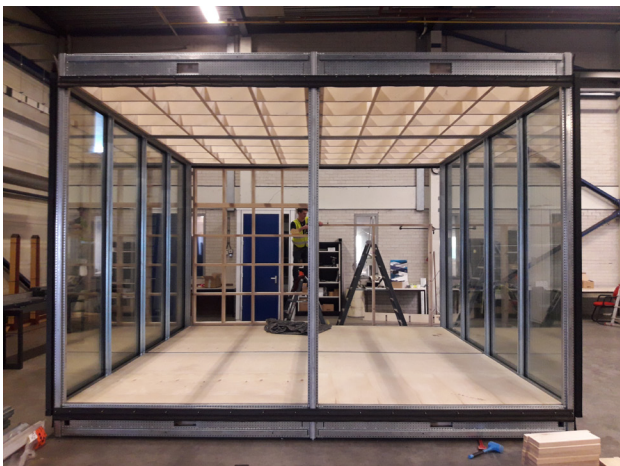

There were many positive learning points that have proven that it is possible to realise fully reversible buildings when applying reversible building design principles. For example, it was proven that it is possible to design a modular component which can be assembled and disassembled as one while also having the additional capacity for internal transformation. This was demonstrated with the wooden cassettes which were disassembled from the facade and reassembled as a floor cassettes. A door had been made in a wooden cassette when it served as a façade element and during the transformation, the door was closed to form a floor.

It was also possible to reposition finishing during transformation, and to place finishing elements into the same steel connectors which had been used for fixing glass panels instead of using their original aluminum profile.

The assembly and transformation process illustrated advantages of interlock connections and the use of intermediary connections at building level in terms of:

- Avoiding damages to the material during assembly and disassembly
- Enabling parallel assembly sequences and
- Speeding up assembly and disassembly processes through quick connection procedures.

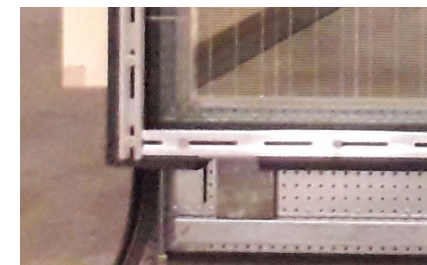
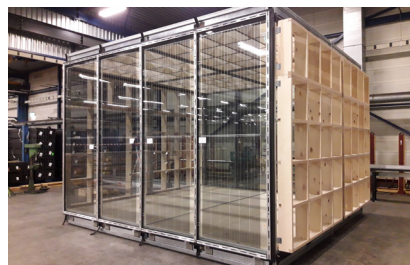
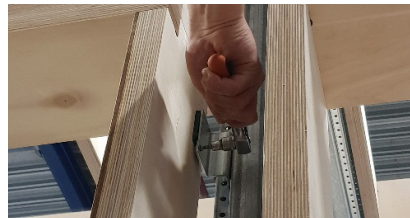

GTBL GREEN TRANSFORMABLE BUILDING LAB

4.5.3. TRANSFORMATION

The transformation of the GTB Lab reversible module dealt with:

- Disassembly of the translucent polycarbonate facade
- Disassembly of two and a half wooden facade cassettes supporting modular translucent polycarbonate facades with 10 air chambers.
- Extension of the steel frame for the terrace.
- Placement of a facade cassette as a floor cassette and closing its door opening by adding additional wooden elements with already premade geometry.
- Placement of the floor finishing.
- Reassembly of the modular translucent facade elements and their connection with existing standardised steel connectors.

The aim of the transformation was to use existing materials from the GTB Lab module and add only the steel frame for the terrace extension.

In order to achieve this, standardisation of dimensions and connections played an important role. The type of connections was also crucial since the replaceable elements should not be damaged during disassembly and reassembly.

The GTB lab circular module was made possible by careful design of reversible connection types which enabled disassembly and exchangeability without damaging the element or connections themselves.



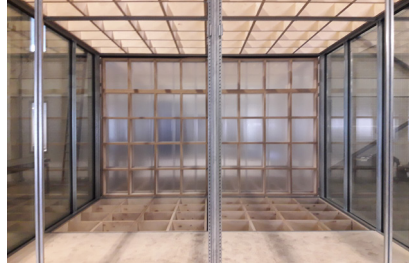

REMs

4.6. REVERSIBLE EXPERIENCE MODULES

4.6.1. DESIGN APPROACH

The pilot project was designed to support both interactions with the materials passports and the multiple build-ups of the main construction. For the consistency of the concept, the interface between the REM modules, the panels, and the aluminum construction frame have also been tested to ensure the durability of the structural integrity of the expo for over a year.

The pilot project combines floor, wall and ceiling elements composed by several basic modules. The main components composing the pilots are: Octanorm Aluminium profiles for wall construction, Octanorm Aluminium ceiling construction, birch panels for printing visual REM modules, Armstrong, Troldekt ceiling system, Lindner floor system, Lighting fixtures

On top of this, 70 materials are integrated as REMs in the exhibition. All REMs are further detailed in the *Manual Guide and in the Visual REMs*.

The physical REMs have a fixed location on the floorplan. The visual REMs can be relocated at different locations within the floorplan with certain exceptions.

XHIBITION - FLOORPLAN

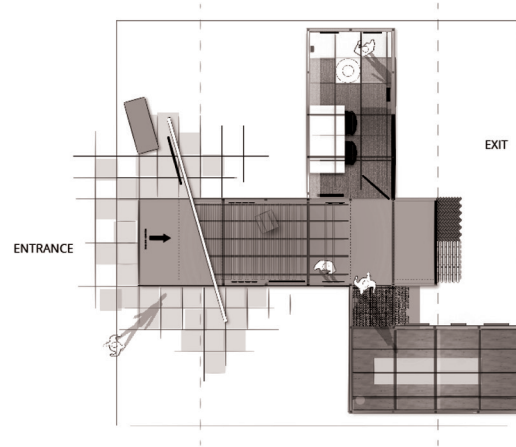

andlotte.eu / hello@andlotte.eu / +31 30 20

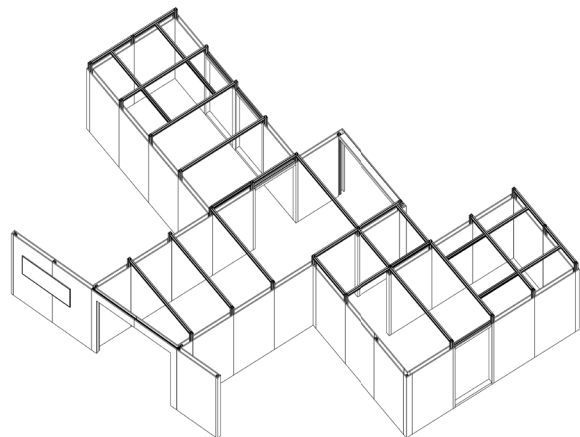

REM EXHIBITION - OPTIONS FLOORPLAN

SMALL (2 M²)

MEDIUM (38,5 M²)

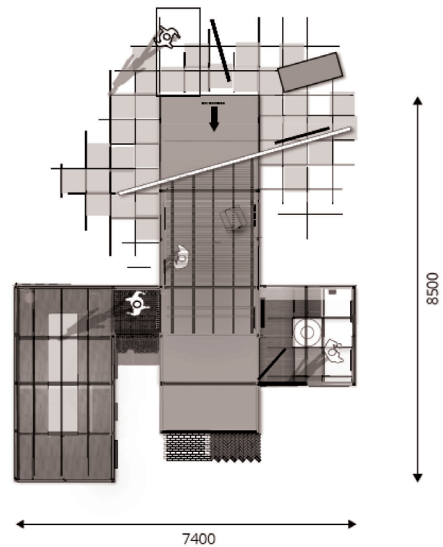
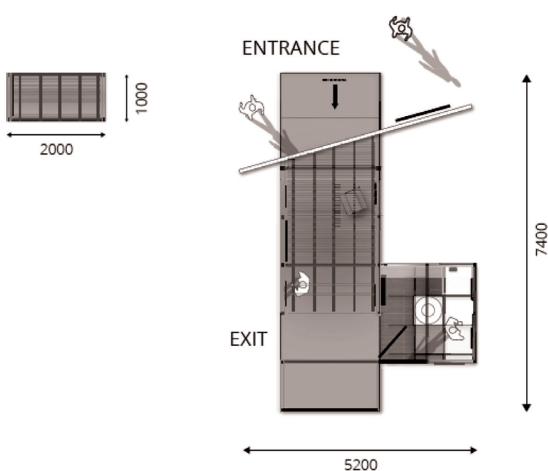

Figure 50: REMs initial plans

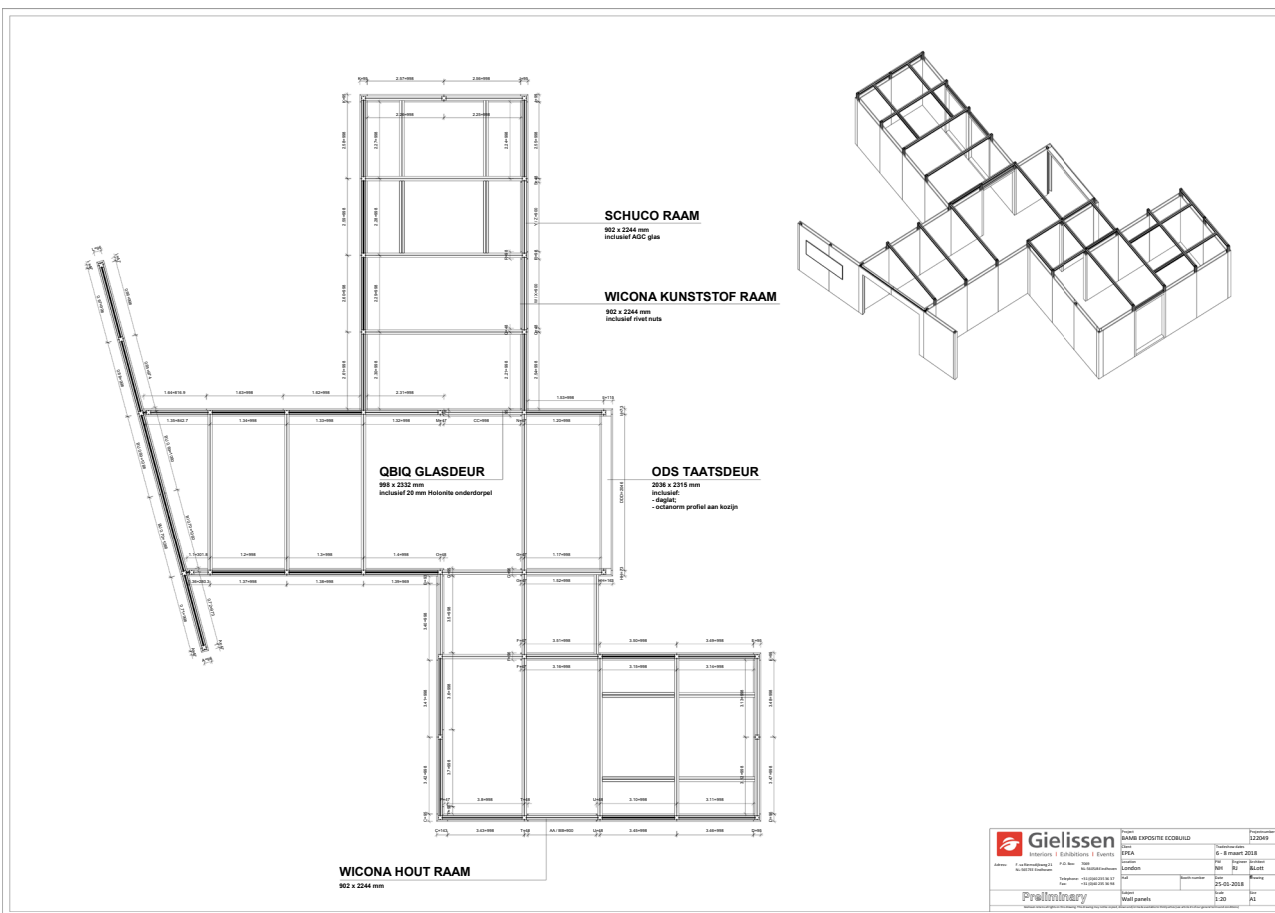

Figure 51: Plans of the exhibition setup for Ecobuilt

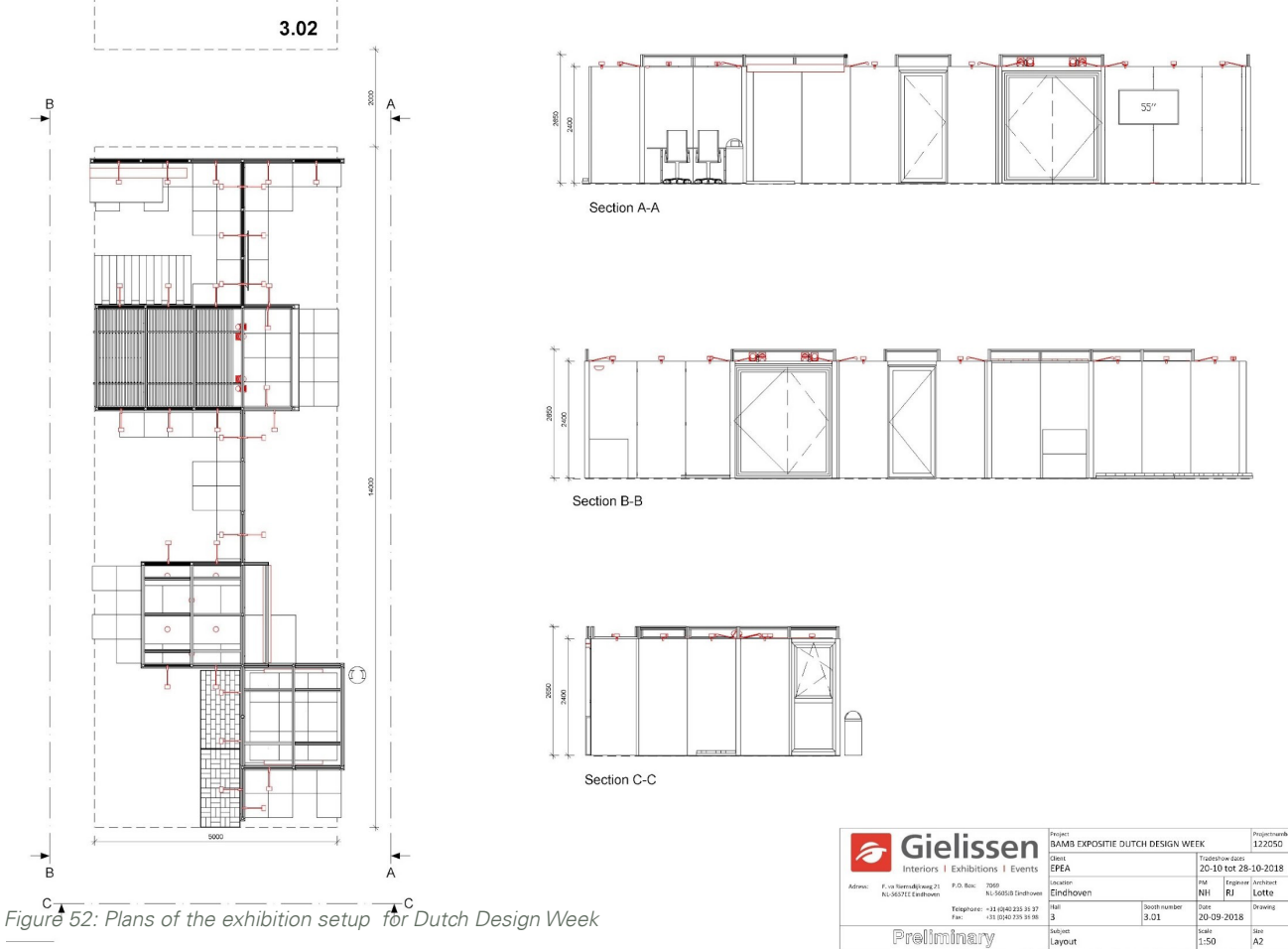
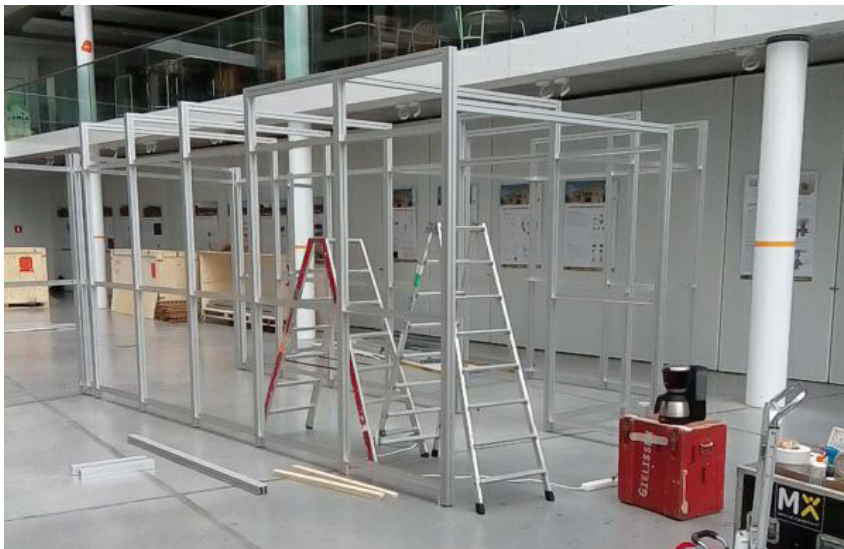

Figure 52: Plans of the exhibition setup for Dutch Design Week

REMs

REVERSIBLE EXPERIENCE MODULES

SPECIFICATIONS OF MATERIALS, TECHNICAL SPECIFICATIONS AND DETAILS ABOUT THE COMPONENTS



The load-bearing space-frame construction is made from **aluminum Octanorm profiles**.

Standardised Birchwood panel dimensions and detailing

To allow flexibility in the placement of the panels in the exhibition frame, each panel has the same dimensions. At outer corners the dimensions of the frame were longer than the panels. To keep the standardised dimensions of the panels, corner specific panels were built and attached to the corners.

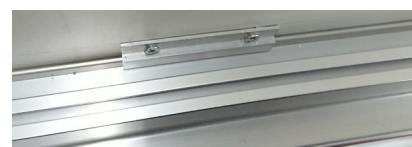

Connection between birch panels and Octanorm profiles

Traditionally birchwood panels would be screwed on a wooden support structure. If reused, this system would quickly deteriorate the wood structure and the aluminium supporting structure after only few instances of connecting and disconnecting the panels. Therefore, a connection method was developed that allowed a strong connection that can be disconnected quickly and repeatedly. The solution uses a slot present in the Octanorm profiles. A hooks made by Z-profiles is screwed in the back side of the birch panels. The z-profiles fit into grooves on the sides of the octanorm profiles. The exact positioning of the z-profiles is easier to adjust by re-screwing in wood than by adjusting welded hooks. The availability of materials and the use of well-known construction principles increase the trust of the workers in reversible design.



Uprights is placed and secured with wing nuts (two per upright)

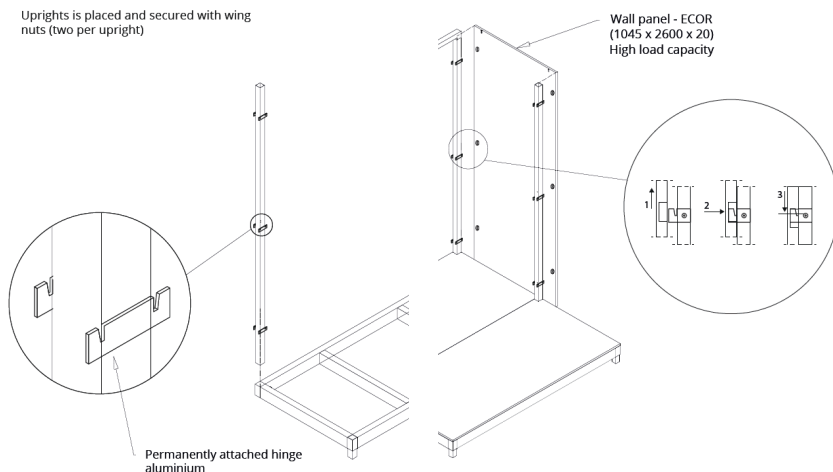

Figure 53: The hooks on the panels in the form of screwed Z-profiles use the already integrated slots in the Octanorm profiles (left).

Horizontal Octanorm profile



Detail of horizontal, vertical and orthogonal profiles and the birch panel



Detail of corner of horizontal Octanorm profile and birch panels with custom screw-connector

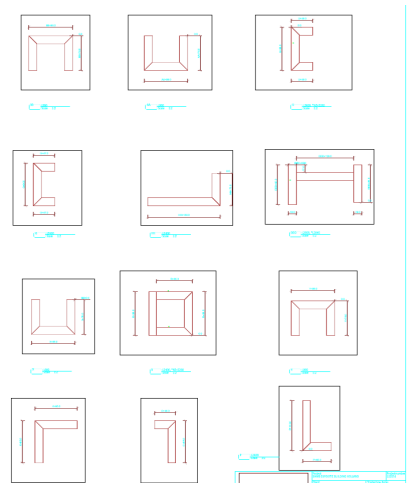

Figure 54: Gielissen developed corner panels to create a smooth finishing whilst keeping the standardized panel dimensions

Lindner raised floor system and exhibition floors

A regular Lindner floor installation achieves stability in part by glueing the columns to the ground floor and attaching the panels to the side walls. This permanent attachment is not possible in the REMs, however to ensure the safety of the visitors, an alternative solution to provide stability was needed. The columns are therefore glued in a portable casing. To provide side stability while maintaining visibility of the system, a transparent side panel is screwed to the plates and the case. The case is transported in one piece in a transport case, and by use of wheels underneath the case. This solution was produced by Lindner and shipped in parts with an instruction manual. In the final exhibition, the construction was reduced to half the size to better fit into the small office unit.



Lighting fixtures and Octanorm profiles

Gielissen normally applies PVC based duct tape to temporarily fix lighting fixtures. To prevent usage of PVC, tie wraps were used instead. Although tie wraps are not reusable for multiple locations, truly reversible solutions like screw fixtures were not possible: the fixtures did not fit readily on the octanorm profiles.



Armstrong - NON Ignis ceiling construction

The ceiling construction is optimised in such a way that the ceiling panels can stay in the ceiling canopy structure during transport to prevent damage to the panels: these are relatively fragile and multiple deconstruction would most probably damage them. Usually ceiling systems are attached to the sidewalls with a perimeter trim system consisting of profiles screwed in the walls. To prevent such fragile connections, the entire ceiling hangs in a canopy system from the overhead octanorm profiles yet remains detached from the walls. An advantage of this construction is the possibility to install side-lighting in the space between the canopy and the walls. Openings for lighting, ventilation, or heating can all be made on the sides of a canopy system rather than requiring holes in the panels, allowing the ceilings panels to remain intact and readily reusable in new setups.

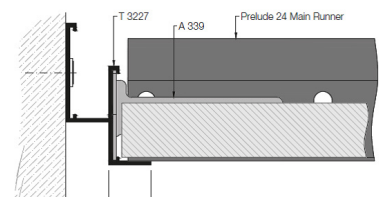
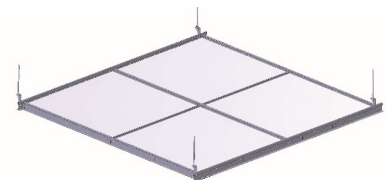

Figure 55: The Armstrong ceiling combined with the wooden NON ignis ceiling panels was installed in the office unit from Ecobuild onwards. The canopy construction also allows for side lighting.

REMs

REVERSIBLE EXPERIENCE MODULES

PICTURES OF THE BUILDING ACTIVITIES, TAKEN DURING THE IMPORTANT PHASES OF THE PROJECT

4.6.2. RELOCATIONS



**Brussels Environment , First setup
BE Stakeholder Network,** January 22nd., Brussels The aluminium Octanorm frame was constructed in only three hours. The full buildup required two days (middle).



Ecobuild London UK, First complete setup

The REMs exhibition was shown at its full size for the first time. All 70 REMs were on display.-Addition of the bedroom unit with large REMs as the Troldekt ceiling, Auping Bed, Luxaflex, and insulation and finishing materials such as Everuse, Doscha, Ecor, Gyproc, PPG, DSM and Graphenstone. -Expansion of the office unit with two base modules, adding large REMs such as the Schuco and Wicona windows, QBIO door, Ahrend Desk and Flokk and Herman Miller chair. Addition of the ODS Jansen pivoting door

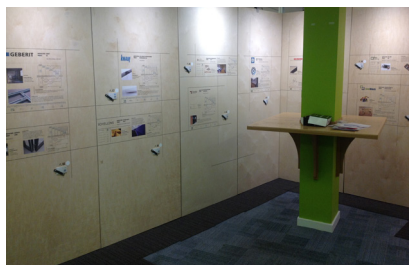
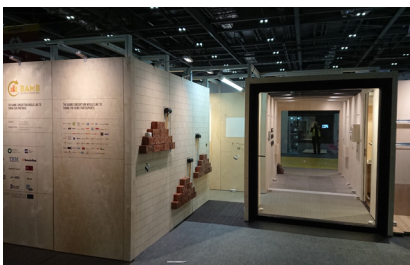

BRE innovation park Watford UK, relocation

The positioning was precise to fit in the provided space. The height of the space was only a couple centimeters more than the height of the exhibition. Columns in the space required a precise positioning of the exhibition. Even though the columns were anticipated as the drawing of the space was shared, the tables attached to the columns were not shown on this drawing. The positioning had to be improvised on the spot

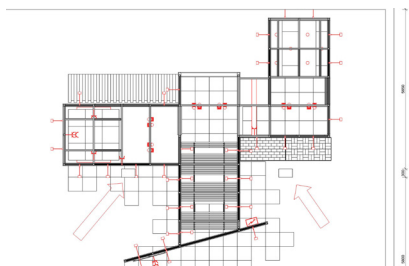



Building Holland Amsterdam NL, Integration of Window frame, Transformations

The available space at Building Holland required a rotated setup, aligned the entrance with the hallway and making best use of the diagonal dimensions of the plot.

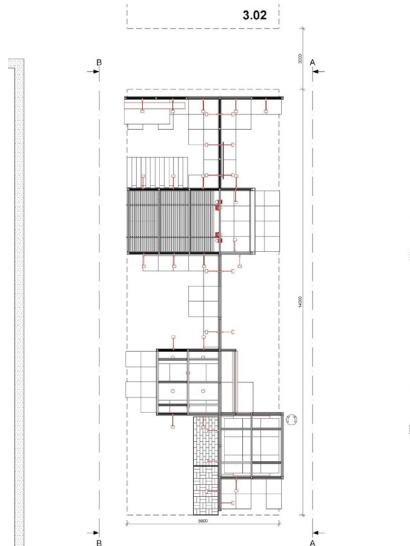
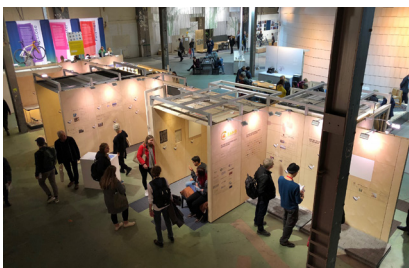

Dutch Design Week Eindhoven NL, Major transformation in open floor-plan

Redesigned the REMs exhibition to become more open and transparent. The construction could be built using only the already available Octanorm profiles. No new profiles were used. All main physical REMs could be integrated, including the doors, ceilings and windows. For several visual REMs there was no place.

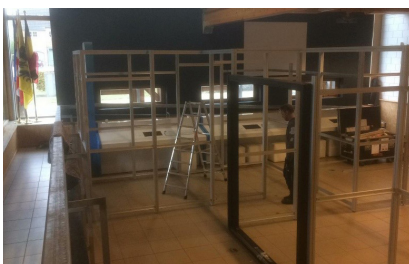

Kamp C Westerlo BE, Compacted setup with reduced office area

The location at KAMP C was smaller than communicated. The office unit was reduced with 1 base-module. The outside panels of the bedroom were left out. The REMs only just fit in the designated area.

CRL

4.7. CIRCULAR RETROFIT LAB

4.7.1. DESIGN APPROACH

CIRCULAR RETROFITTING

Initially conceived by architect Willy Van Der Meeren as a temporary solution, the prefabricated concrete modules were installed, on the campus in the 70's to cope with the increasing demand for student housing on site. The flexibility of this modular system developed in Switzerland allowed a random layout and generated a sequence of qualitative green urban spaces.

Since the ageing student housing no longer met current insulation and ventilation requirements, their complete demolition had been considered by the university. However, a case was made to keep part of these units for their architectural specificity and to prevent them turning into waste. The renovation of the modules should maintain the urban identity of the site while including flexibility for future transformations. This ambition has driven the retrofitting strategy of the Circular Retrofit Lab.

After the first renovation phase, the Circular Retrofit Lab will host a dissemination space focusing on circularity and a flexible workspace. Subsequently, the building will be transformed into an eco guest-house for visiting academics.

REVERSABILITY

The pilot project explores in depth the reuse potential and the transformation capacity of an existing building at different levels: building, space, constructive systems and components.

The design process started with a preliminary study. The team identified and studied future potential development scenarios. This research by design process increased the flexibility and the adaptability of the final plan lay-out and its capacity to accommodate future functional transformations, with little waste (Figure 56 & Figure 57).

Two transformation strategies were selected and developed within the project: an internal and an external transformation (Figure 58).

The internal strategy detailed in the *prototyping report (D13)* aimed to develop and implement circular partition systems related to their expected change rate (Figure 68 on page 69). A series of existing products were tested and upgraded to become circular.

The development of the **external transformable solution** for the facade encountered major challenges. The integration of the current building standards and the respect of the heritage value of the site had to be taken into consideration. A mock-up was realised before building the actual facade.

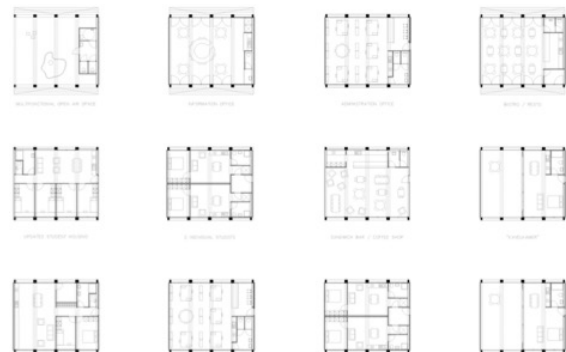

Figure 56: Research by design, identification of the scenarios



Figure 57: Subsequential functional transformation



Figure 58: Internal, external transformation and reconfiguration

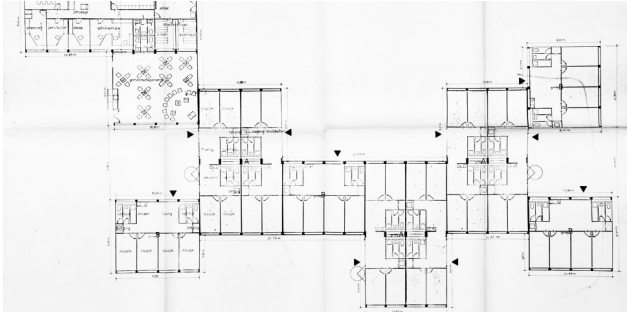

Figure 59: Original composition

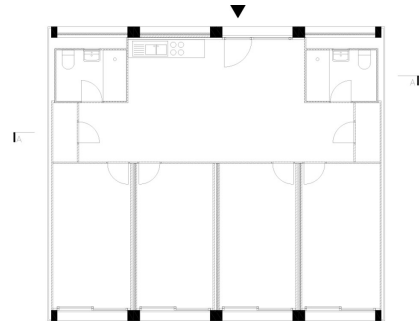
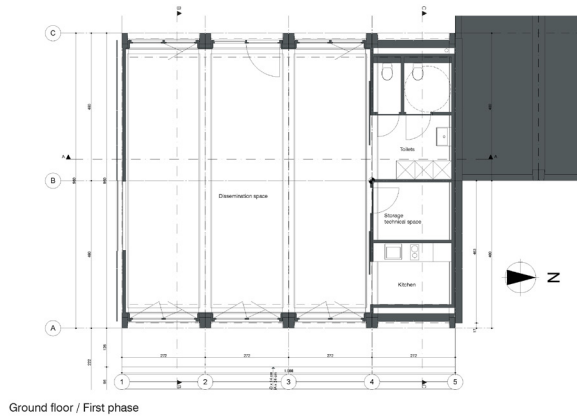
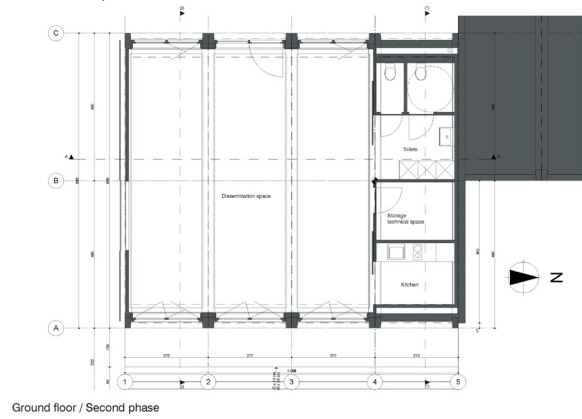

Figure 60: Original plan of a cluster of 4 modules, containing 4 student rooms, 2 bathrooms, 2 storages spaces, a kitchen and common space



Ground floor / First phase



Ground floor / Second phase

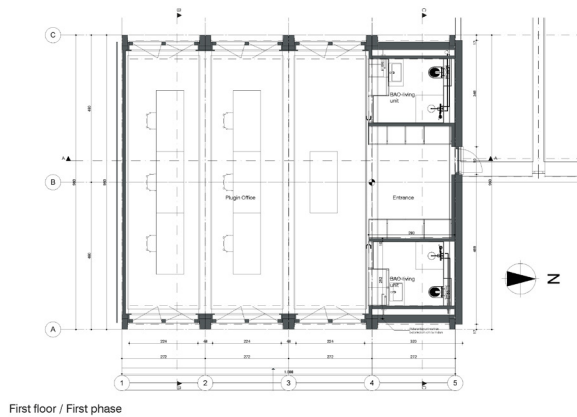

First floor / First phase

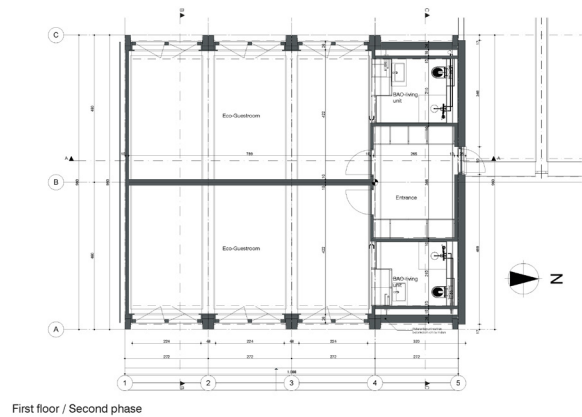

First floor / Second phase

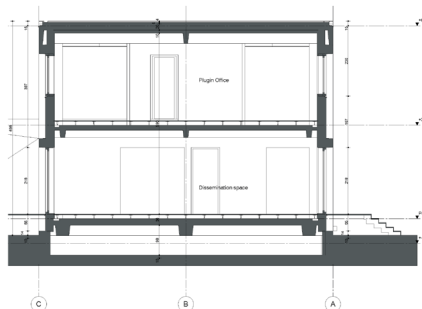

Figure 61: First renovation phase

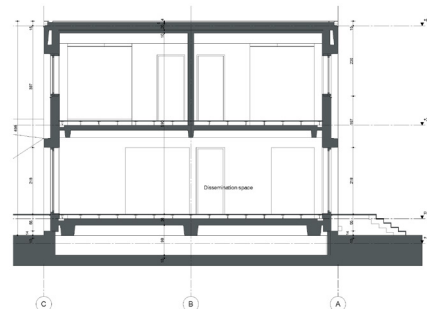

Figure 62: Transformation phase

CRL

CIRCULAR RETROFIT LAB

SPECIFICATIONS OF MATERIALS, TECHNICAL SPECIFICATIONS AND DETAILS ABOUT THE COMPONENTS

REVERSIBLE CAPACITY OF THE EXISTENT BUILDING

MATERIAL: The structure of the existing building was entirely made of pre-stressed concrete, a pre-fabricated element with high load bearing qualities. Concrete has a high environmental impact. Renovating and reusing the building structure extends its useful life and limits the impact compared to a new construction.

SYSTEM VARIEL© MODULE is a standardised concrete prefabricated system, developed after WW2 by the Swiss architect Fritz Stucky. Initially conceived to serve as a single room, the module could be assembled in series allowing vertical and horizontal expansion. Two of the CRL modules comprise a bathroom module, set back 40 cm from the facade to provide shafts for technical services.

SPATIAL SYSTEM: The retrofitted student housing module comprised 2 floors of four Variel© modules each. The juxtaposition of the modules is creating an open plan that can fit different interior layouts. To preserve this intrinsic flexible quality, only the concrete frame structure of these modules is used for the transformation of the building.

BUILDING SYSTEM: Variel© modules can be stacked in different spatial setups. The system was conceived to be piled up. It can become a multi-storey building. Parts of the buildings (modules) can also be relocated.

URBAN SYSTEM The flexibility of the module allowed to create a qualitative urban spatial system. The repetitive units contributed to a strong identity of the VUB campus.

Figure 66: The urban potential and horizontal expandability of the Variel© modules



Figure 63: Existing circular capacity,

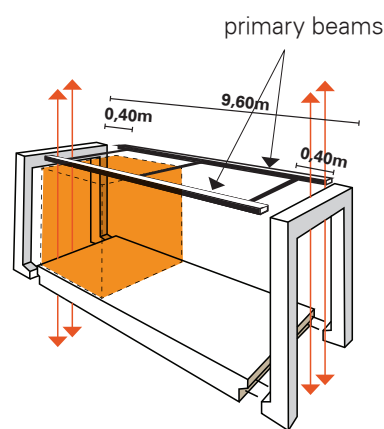

Figure 64: Variel system

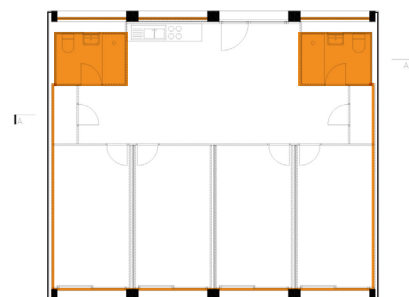
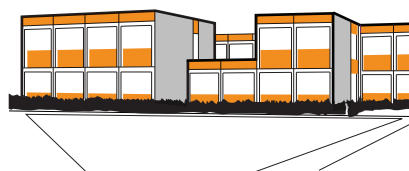

Figure 65: Existing flexibility



RENOVATION STRATEGY

MATERIAL: The modular concrete structure of the initial building was stripped and re-used to its full potential. Other elements of the building, including concrete facade panels, had to be removed because they contained dangerous materials, such as asbestos, or were of insufficient quality. The tri-dimensional concrete grid was sanded and repaired and a new circular reversible envelope and interior partitions were fitted into it.

Plan layout and technical services

The two initial bathrooms were removed to integrate technical services more efficiently, ease functional transformation, and maximise available space and daylighting. Ventilation, water and wastewater circuits are short and easily accessible for maintenance thanks to visible installations and a technical floor with removable tiles and plinths.

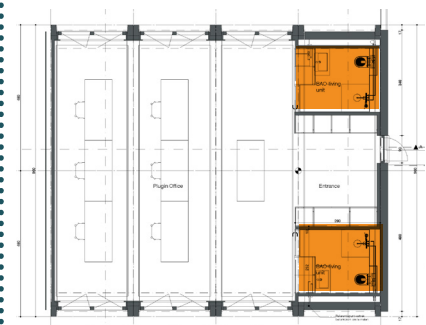

Figure 67: Efficient organisation of the space and technical services.

Identity

The identity of the building was preserved by keeping the concrete structure visible and respecting original design features and colours.

Phasing and repeatability

By keeping the original appearance, the refurbishment is likely to preserve the urban qualities of the site and allow a step-by-step refurbishment within the campus.

EXTERNAL RENOVATION STRATEGY

MATERIAL: The use of sustainable materials in the production of the facade elements was a criteria for the choice of contractors.

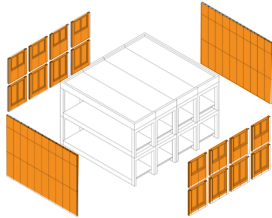

Modular standardised solutions for a prefabricated modular structure

A system of prefabricated interchangeable insulated wooden panels was used to fill in the stripped structure. As finishing layer, panels were screwed on the watertight membrane by using wooden battens as intermediaries. The cement panels preserve the visual identity, are interchangeable and can be re-used for all the other facades.

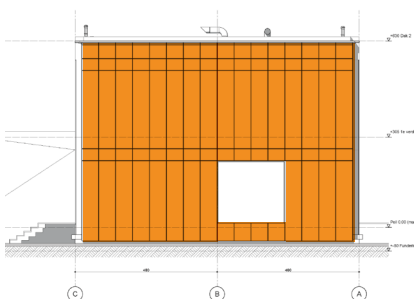

Waste All the materials and products are inter-changeable and reusable. The water-proof membrane is attached to the system and can be reused together with the whole panel. Only the airtightness tape will likely become waste after disassembly.

INTERNAL RENOVATION STRATEGY

MATERIAL: The project uses systems existing on the market with high circular potential. The team focused on extending the life span of these products and reducing the use of raw materials.

Change rate Internal wall transformation strategy is related to the expected change rate of each partition wall.

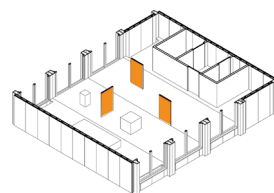

TYPE 1 HIGHER RATE OF CHANGE

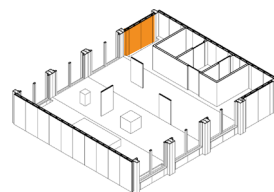

TYPE 2 HIGH TECHNICAL FLEXIBILITY

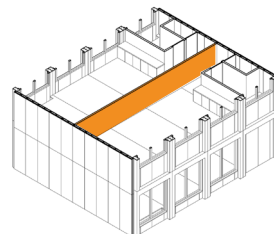

TYPE 3 INTERMEDIATE RATE OF CHANGE

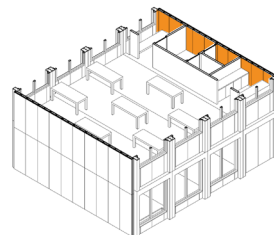

TYPE 4 LOW RATE OF CHANGE

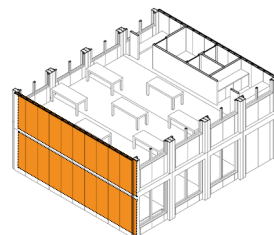

TYPE 4 LOW RATE OF CHANGE

Figure 68: Wall transformation strategy

TRANSFORMATION STRATEGY

The transformation of the second floor from a flexible workspace into an eco-guesthouse for visiting academics (phase 2) is considered from the start.

Prepare the change

The walls between the future guest rooms and circulation area need to be fireproof to comply with the codes for residential use. Although this was not necessary in the first non-residential phase, and more resource intensive, these walls were already installed to meet the requirements (see orange-red walls Figure 69) and avoid future disposal and waste creation. The orange-red dotted line Figure 69 represents the walls that will be mounted during the second phase.

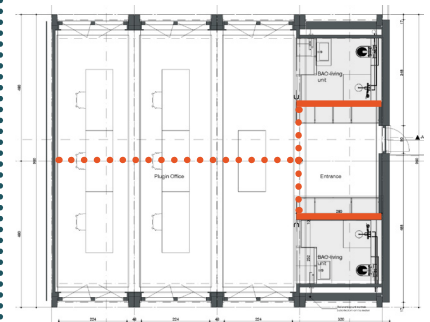

Figure 69: First floor, first and second phase

Necessary trade-offs

At the time of construction, the prototyped reversible wall systems did not yet have the necessary certification to comply with the fire safety measures of the building codes. If not attained by the planned transformation, a less circular solution might have to be implemented for the addition of a separation wall.

For the same reason, a non-reversible but certified ceiling was implemented on the ground floor to accommodate residential use on the first floor.

CRL

4.7.2. EXTERIOR RETROFITTING

FIRST STEP: THE FACADE MOCK UP

The prefabricated circular facade solution was developed with the industrial partners, during a mock-up exercise that used another campus concrete module. The team developed a demountable facade panel that can easily be inserted in the concrete frame, by using the side openings (Figure 70). The panels are attached with standard L profiles using simple bolted connections that can easily be (dis)assembled. Gaps between the panels and structure were filled by insulation and covered with a water and airtightness membrane.

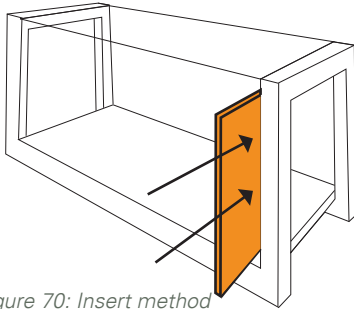

Figure 70: Insert method

RELOCATION OF THE MOCK UP

Initial plan foresaw the relocation and the installation of the mock-up in the CRL. This was not possible due to the dimensional differences between the modules. The team used this lesson learned to enhance the precision of the execution the quality check.



THE MOCK-UP

FACADES PANEL COMPOSITION

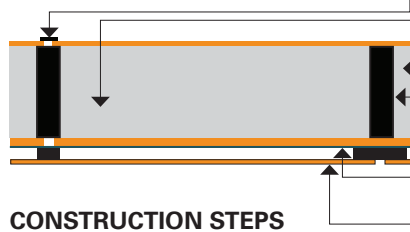

- VAPOUR BARRIER SEALING TAPE
- CONSTRUCTION BOARD WITH INTEGRATED AIRTIGHT AND VAPOUR BARRIER, MECHANICALLY FIXED
- INSULATIONS (120MM+60MM)
- WOODEN SUBSTRUCTURE FOR THE FACADE CLADDING 22X45MM / 23X100MM
- WATERPROOF LAYER
- CEMENT/WOOD FIBRE 8MM PANEL MECHANICAL FIXED-WOODEN BEAMS 45X184MM EVERY 600MM
- FIBRE-CEMENT FACADE CLADDING PANEL 8MM

CONSTRUCTION STEPS



INITIAL FACADE



STRIPPED CONCRETE STRUCTURE



SANDED CONCRETE STRUCTURE



INSULATION WATERPROOF PANELS INFILL



FIBRE-CIMENT CLADDING

EXECUTION AND PRECISION :

Inserting the panels requires extreme precision. The future transformation capacity resides in ensuring that the panels are interchangeable and that the dimensional margins are allowing the switch.

While the modules are standardised, the contractor identified some differences between them (Figure 71). This information is essential for the future transformation and should be part of the product passport, or registered in a very clear and simple way in the BIM.

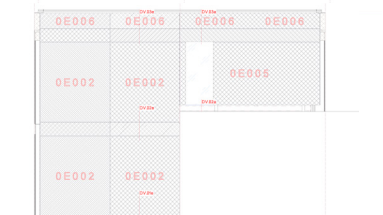
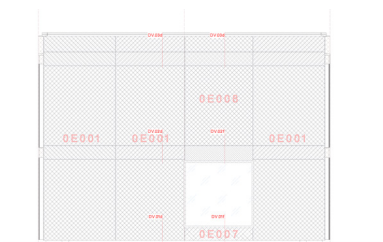
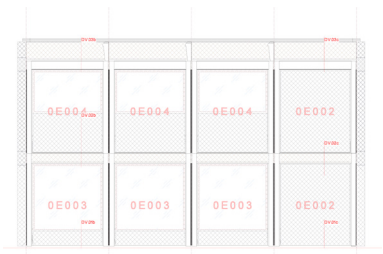
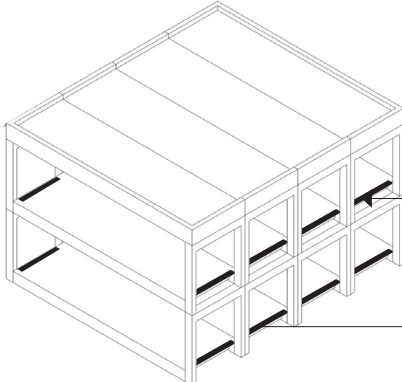

Figure 71: Facades CRL, Precision for future components exchange

PREPARATION AND SYSTEMS



CONNECTIONS

- **CUT OUT THE CONCRETE SLAB** TO ALLOW THE PLACEMENT OF INTERIOR INSULATION AND AVOID THERMAL BRIDGES



COHERENCES AND TRADE-OFFS

The choice to keep the appearance of the initial building demanded special attention to fulfill the energy efficiency requirements and avoid the potential of indoor relative humidity impact. Not all the thermal bridges could be avoided but the continuity of the insulation on the interior side was maximised to optimise the building performance within the project constraints.

South facades

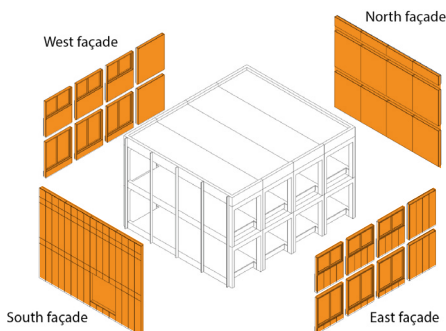

- **EXISTENT STRUCTURE** PRETENSIONED CONCRETE / VIEW
- **CONNECTIONS** STRUCTURAL ELEMENTS / VIEW
- **PANELS** PREFABRICATED ELEMENTS / SECTION

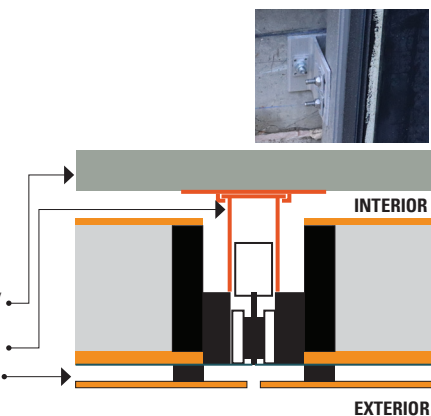

BETWEEN ALUMINIUM PROFILES

North facades



- **WOODEN BEAM** SUPPORT, CONNECT THE PANELS
- **CONNECTIONS** SCREWED PROFILES
- **PANELS** BOLTED ONTO THE CONCRETE FLOOR

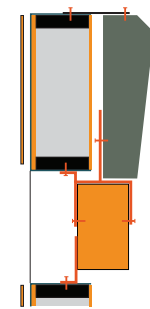

INTERCONNECTED THROUGH WOODEN BEAM ELEMENTS

East and West facades



- **INTERIOR INSULATION** PLACED AFTER REMOVING PARTS OF THE INTERIOR CONCRETE FLOOR SLAB
- **CONNECTIONS** STRUCTURAL ELEMENTS
- **EXISTENT STRUCTURE** PRETENSIONED CONCRETE



- **ALUMINIUM WINDOWS** FRAMES
- **TRIPLE-GLAZING** WINDOWS

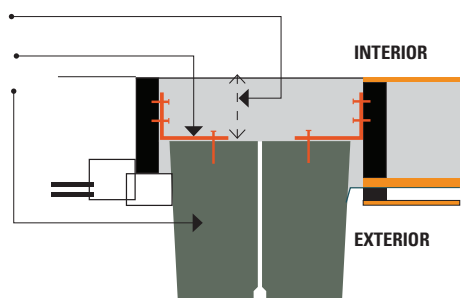

WITHIN THE CONCRETE FRAMES,

Figure 72: Schemes based on the technical details provided by the CRL team

CRL

4.7.3. INTERIOR TRANSFORMATION

FIRST STEP: PROTOTYPING

The choice of the interior walls is the result of a long process that started during the feasibility study and continued in the "experimentation lab". During 2016 and 2017, the modules to be retrofitted were not yet available and the VUB team already tested the interior walls in another module identical to the CRL. Later, a transformation of this space allowed testing their disassembly, reuse and reconfiguration.

The systems developed by the project are based on existing products. These products are on the market and have a high potential to reach circularity objectives as envisaged within BAMB. Together with concerned industrial stakeholders, the systems were developed into reversible systems, evaluated and compared to each other. The

objective of this exercise was to create a catalogue of different partition walls for different contexts, user needs, economic conditions, and functional requirements.

TESTED SYSTEMS

The **Geberit GIS** system (P1) was developed by Geberit for the prefabrication of sanitary facilities. By adapting and adding elements to Geberit GIS, the team focused on the development of a kit of parts for flexible and multi-functional solutions.

Saint-Gobain: Two products were selected, compared and evaluated. Type 1 (P2) is a preassembled, wood frame system with gypsum fibreboard cladding. Type 2 (P3) is a demountable and reusable wall system composed of metal-stud profiles and fibreboard

connected with visible joints.

Wall-linQ (P4) is a drywall system with cardboard frames. Although its impact is very low, the system does not allow reuse. It was not implemented in the final project, but was described in the *D13 report*.

Systimber (P5) is a prefabricated interior and/or exterior wall and floor system made of laminated wooden beams that are connected by a metal bolt system.

The **JuuNoo** system was not tested in the prototyping phase, but was implemented in the lab later. Thanks to adaptable metal frames and reversible Velcro connections the system can quickly be installed, dismantled and relocated or reconfigured.



Figure 73: Transforming Lab

TEST CONSTRUCTION

During a first and second workshop the research team together with a group of students installed the different interior wall systems following the traditional floor plan of the student houses.

FEEDBACK + IMPROVEMENTS

The different workshops provided feedback on the reversibility aspects of the different systems, allowing improvements to be made intermediately. This feedback was also communicated to the manufacturers.

CONSTRUCTION

In a final workshop, the partitioning walls were partially or entirely dismantled and reused, removed or reconfigured depending on the systems' characteristics in terms of reuse and versatility, creating a more dynamic lay-out for dissemination events.

Original: stripped space

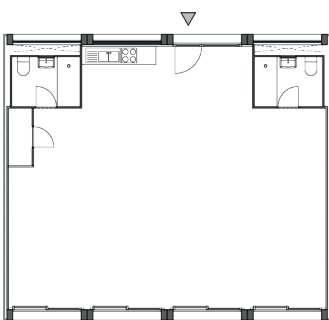

Transformation 1: four rooms

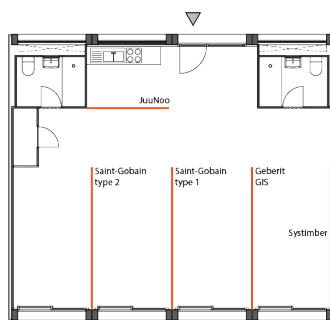

Transformation 2: dissemination space

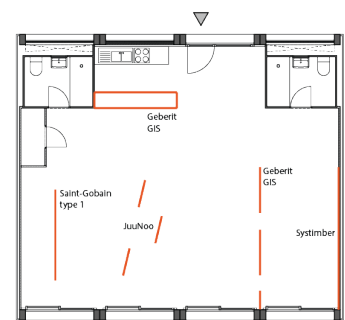

Figure 74: Transformation of the test lab after the first workshop to the development of the event space in the second workshop.



Figure 75: Transforming Lab during the tests

CRL

TEST CONSTRUCTION

GEBERIT GIS TESTING

During the testing of the Geberit GIS system the Circular Retrofit Lab team improved the initial product's qualities in terms of reversibility, reuse potential, and speed of (dis)assembly. They tested multiple configurations related to height, wall thickness, stand-alone solutions, etc. Achieving a standardized, adaptable and reusable GIS wall system for multiple applications involves the design and testing of new connection techniques. Demountable more resistant boarding replaced the traditional finish with gypsum pasteboards.

The aim was to complement the existing GIS building kit catalogue of functional solutions with fully reusable solutions. The kit of parts offers an opportunity to develop multi-functional products such as partitioning walls, interior furniture, or an exhibition modules.

FEEDBACK + IMPROVEMENT

Connections and cover

Different improved solutions were identified during this workshop:

The extension of the current GIS kit of parts catalogue to a broader field of applications opens its use to a larger group of future users at a lower price. The team developed low tech reversible connectors, reversible suspensions of (wall) boarding, invisible connections, airtightness solutions to increase acoustic comfort. The team explored the multipurpose capacity of the kit. Students developed furniture;

CONSTRUCTION

Disassembly and reconfiguration

- The dismantling of the wall assembled with the GIS profiles was very simple and time efficient.
- All dismantled elements and connections can entirely be reused.
- Elements are not damaged
- The assembly of the wall was not sequential. It was possible to remove parts of the wall in any place. Two new openings were created.
- The building kit was comprehensible
- The building kit allowed the disassembly of the wall piece by piece by one person.

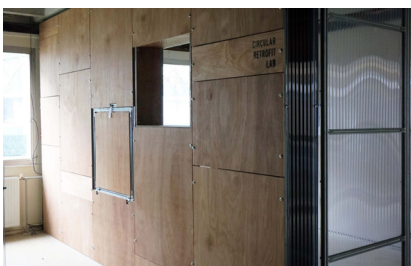
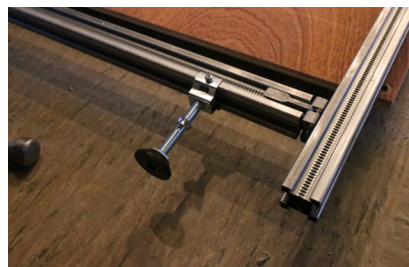
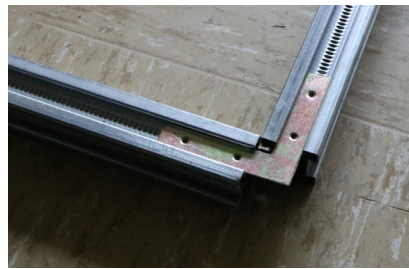



CIRCULAR
RETROFIT
LAB

GEBERIT GIS PROTOTYPING

CRL

TEST CONSTRUCTION

SAINT-GOBAIN TYPE 1 TESTING

The Saint-Gobain prototype 1 is a pre-assembled wood frame system with soft insulation and gypsum fibreboard cladding. The combination of pre-assembled modules enables building up a wall in a short time span. The sequential assembly does not allow individual removal or replacement. Components are mechanically connected with nails, which makes the elements difficult to disassemble without creating waste. The wall elements are quite heavy and should therefore be installed with two or preferably three people.

FEEDBACK + IMPROVEMENT

Connections

The research team proposed to replace the non-reversible nail connections between the different components of the preassembled elements with bolts to allow for individual component reuse and replacement.

A second prototype included a removable plinth system, behind which services can be reversible and accessibly installed.

CONSTRUCTION

Disassembly and relocation

The system allows full demounting with very few waste (only some screws). The wall could be relocated easily. Some of the prefabricated elements were disassembled, the components of which were reused by the students to develop furniture pieces.

Some issues were identified:

- The system is sensitive to tolerances, e.g. small deviations in the floor to ceiling height, crooked screws.
- The fibreboard is prone to fracturing at the connection to the floor and ceiling (after repeated assembly and disassembly).





SAINT-GOBAIN TYPE 1 PROTOTYPING

CRL | © TRANSFORM

CRL

TEST CONSTRUCTION

SAINT-GOBAIN TYPE 2 TESTING

The Saint Gobain prototype 2 is an alternative version of the classic metal stud walls, with visible jointing elements between the fibreboards and insulation between the steel frame. A U-shaped omega profile allows clamping the finishing panels instead of bolting them directly to the frame. This allows easily removing or replacing the panels and limits potential damage. The steel frame can be installed reversibly as well. The frame needs to be installed very precisely for the panels to fit.

FEEDBACK + IMPROVEMENT

Integrated services

An important improvement was the addition of a removable plinth system for the installation of integrated services. This strengthens the independency of the system, in which different components from different layers (structure, finishing, insulation, services) can easily be replaced following different timespans.

The second prototype consisted of a different finishing, using more qualitative and aesthetic fibreboards.

CONSTRUCTION

Disassembly

The wall was disassembled during the transformation of the experimentation lab. It was removed without damaging the components, except for some screws.

Some issues were identified:

- The disassembly sequence was not immediately clear to the students.
- The plinth was difficult to remove.
- The bottom steel profile was damaged during disassembly.
- The dismantling of this system is more time-consuming, but since the system consists of smaller components, can be done with few people.

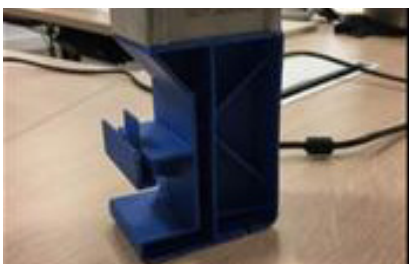



SAINT-GOBAIN TYPE 2 PROTOTYPING

CRL | © TRANSFORM

CRL

TEST CONSTRUCTION

SYSTIMBER INSTALLATION

The Systimber system consists of prefabricated wooden beams that are connected with steel spacers. Rubber bands seal the connections. The system is easy to install, is quite robust and has a low impact thanks to its materialisation.

The sequential assembly of the beams does not allow individual removal or replacement of the components.

FEEDBACK + IMPROVEMENT

Integrated services

The system does allow the addition of integrated services through removable layers. This improves the versatility of the system in being applied for interior wall partitioning (it's initial use is for rapidly assembled load-bearing elements).

CONSTRUCTION

The Systimber wall was not moved or removed during the last workshop.





SYSTIMBER

CRL | © TRANSFORM

CRL

TEST CONSTRUCTION

JUUNOO INSTALLATION

This system was not tested in the prototyping phase, but was integrated in the experimentation lab and the final Circular Retrofit Lab due to its very interesting approach towards reversible wall assembly. The prefabricated metal frames are adaptable in height and can very quickly be installed. The frames are connected to floor and ceiling through reversible Velcro connections. The frame can be filled with insulation. Lightweight fibreboard panels are attached using the same connections.

FEEDBACK + IMPROVEMENT

Improved frames

Different versions of the systems have been developed by the manufacturer to improve the acoustic performance, impact resistance, installation efficiency and lower the cost. The last prototype that was installed in the experimentation lab consists of sigma profiles with improved acoustics. The elongated H-shape of the elements allows reducing the material use compared to the previous version and can more compactly be stored and transported.

CONSTRUCTION

Disassembly and reconfiguration

The JuuNoo system is very easy and intuitive to disassemble, even with only one person. During the final workshop, the system was reconfigured to be used not as a continuous wall, but as movable presentation walls.

Some issues were identified:

- The connection between the Velcro and the ceiling is strong and can result in damage.
- The system can be easily and repeatedly be disassembled and relocated. This can lead to wear and tear, e.g. damaged edges of the fibreboard panels.

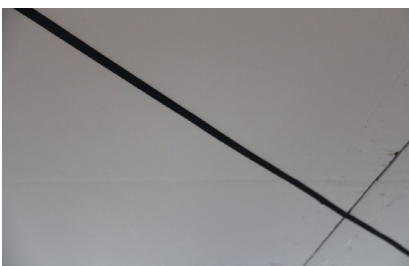



JUUNOO

CRLJ © TRANSFORM

CRL

The analyses of the wall systems, their testing, improvement and implementation revealed a list of twelve criteria, all of them related to the concepts developed by on-going work within BAMB (WP2 and WP3):

1. Reversible connections
2. The speed of assembly/disassembly (e.g. preassembly, fast connection techniques, etc.), the simplicity
3. Use and reuse of reclaimed building materials (e.g. recuperated finishing panels, profiles, etc.)
4. Sensitivity to damage (strengthen elements)
5. Aesthetic of the structural element (connections)
6. Acoustic comfort
7. Flexible integration of technical systems
8. Independence of the system (e.g. can one part be replaced?)
9. Low initial cost
10. Low initial environmental impact
11. The kit of parts: possibility to demount and reuse (e.g. standardisation) dimensional tolerances
12. High energy efficiency

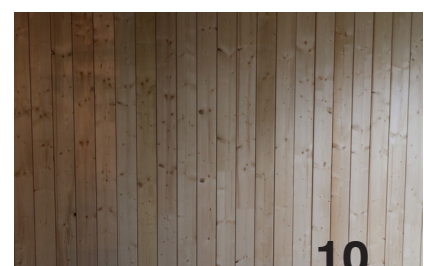
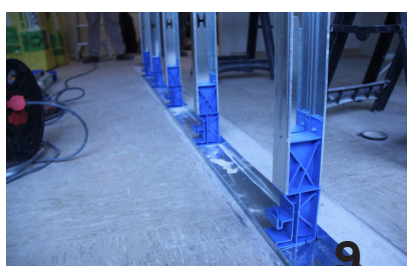

THE CHOICE OF THE INTERNAL STRATEGY

TYPE 1 HIGHER RATE OF CHANGE

LOCATION: dissemination room (ground floor) and offices (1st floor)

CRITERIA:

- (Dis)assembled in a short time
- Reusable building components
- Reversible connection techniques
- Allow multiple (dis)assemblies
- Flexible space

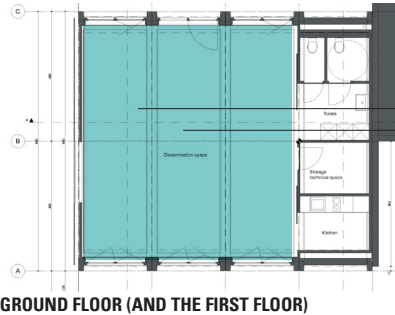

GROUND FLOOR (AND THE FIRST FLOOR)



SYSTIMBER

TYPE 2 HIGH TECHNICAL FLEXIBILITY

LOCATION: technical walls to adjust, adapt, repair and maintain the technical services that are behind, the finishing panels/plinths

CRITERIA:

- Allow multiple reuse
- Allow multiple (dis)assemblies
- Preserve good acoustic properties

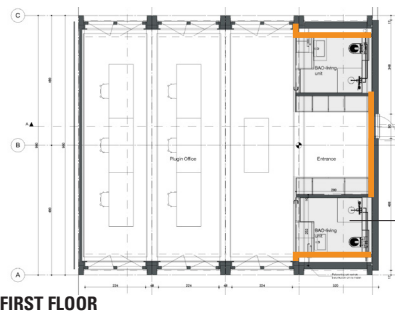

FIRST FLOOR

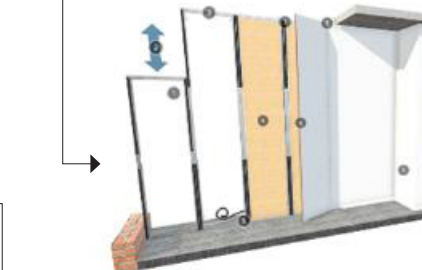

JUUNOO WALL SYSTEM

■ GIS prototype wall

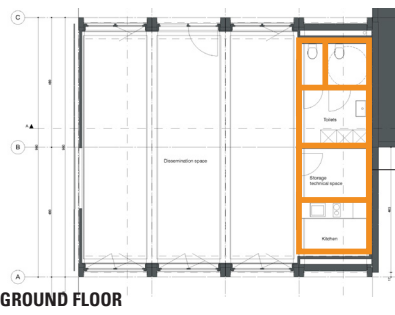

GROUND FLOOR



GEBERIT

TYPE 3 LOWER RATE OF CHANGE

LOCATION: The partition walls between the two eco-guestrooms

CRITERIA:

- Comply with acoustic standards
- Comply with fire safety regulation
- Flexible integration of technical functions

- Saint-Gobain Dry-wall (fire rated)
- BAO Living prefab module

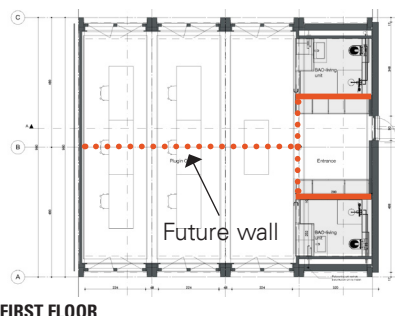

FIRST FLOOR

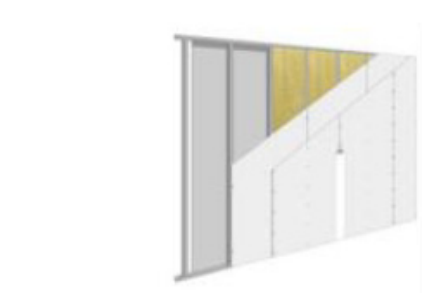

GYPROC SAINT-GOBAIN FIRE SAFETY

TYPE 4 LOW RATE OF CHANGE

LOCATION: The closed south facade and wall surfaces under the windows

CRITERIA:

- a low environmental life cycle impact
- reuse of components at the end of functional life

■ Saint-Gobain prototype wall



GROUND FLOOR (AND THE FIRST FLOOR)

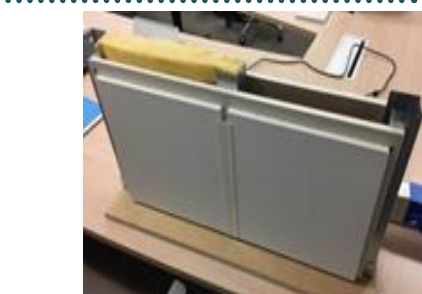

GYPROC SAINT-GOBAIN CIRCULAR PROTOTYPE

CRL

4.7.4. WORKSITE

CIRCULAR RETROFIT LAB



The retrofitting of the student houses to create the Circular Retrofit Lab started from the fully stripped concrete module frames. Therefore, the existing building had to be largely deconstructed, unfortunately without allowing much reuse and thus producing quite a lot of waste. The building permit for this retrofitting project includes both residential and non-residential functions, complying with the most severe regulations to simplify future transformations.

The retrofitting of the student houses to create the Circular Retrofit Lab started from the fully stripped concrete module frames. Therefore, the existing building had to be largely deconstructed, unfortunately without allowing much reuse and thus producing quite a lot of waste.

First, the roof was insulated and covered with a watertight membrane, which can be removed.

The specificity of the modular concrete structure and the design choice to keep the structure visible externally, maintaining the identity of the original design by architect Willy Van Der Meeren, required some specific solutions and concessions. The installation of the façade elements on the inside of the structure required to make cutout in the floor. The crawling spade underneath the concrete module had to be insulated. Thermal bridges will remain where the concrete beams penetrate the envelope of the building.



The installation of the façade elements could be done in only two days, thanks to the prefabrication and the simple bolted connections. Apart from requiring a crane to lift the elements, no complicated tools were required.



All elements follow the same standard sizes (based on the modularity of the concrete structure). The size had to be adapted between the installation of the mock-up and the final façades to better comply with the dimensions of the structure. One side consists of full height elements, which can only be used on this one façade. All other elements can be interchanged throughout the four façades of the building.



The façade elements were fully prefabricated, already including window frames and waterproofing. This saved a lot of time on the construction site. As the elements are fully integrated, they can be installed as a whole, and can also later be removed and relocated as such.





The connections used for the façades are very simple and easily reversed, consisting mainly of metal profiles and bolts.



The standardisation of the facade panels allows direct reuse in different façades of the building. This required developing some additional details, like the addition of the wooden beams in the North facade, to cope with the dimensional differences.



To comply with the required performance levels with respect to insulation, water- and airtightness, different custom solutions had to be applied.

Flexible rubbers fill the gaps between the facade elements and the concrete frames.



Waterproof membranes and sealing tapes provide watertightness.



The holes in the floor were filled with insulation to provide a continuous exterior layer. Foils were added to ensure airtightness of the facade. As these details are very case dependent (defined here by the specific character of the concrete module), many of these solutions will likely not allow reuse after dismantling. As the majority of the façade is made up of the prefabricated elements, the waste produced will still be minimal.



Together with the relevant stakeholders, the VUB team integrated innovative techniques for the services as much as possible, including a smart grid and plug-and-play installations.



All technical installations and services are installed in a dry and reversible way. Moreover, they are made accessible for maintenance and replacement in three different ways: (1) using cable trays that are mounted on the ceiling, (2) installing services in removable plinths or behind removable finishings of the interior wall systems and (3) placing pipes underneath the dry floor system.



The floor contains hatches at strategic spots to provide access to services and technical installations.



Most of the tested and implemented interior wall systems allow integrated services behind removable plinths.



This project shows how a qualitative renovation can be done using circular building solutions, considering an existing context and boundary conditions. On the other hand, it shows how practical aspects like building codes, permits and legal responsibility still impede some of the more ambitious design choices.



Industrial stakeholders, like manufacturers, were involved from the design phase, but also during the progress of the works. This allowed co-developing the systems and making intermediate improvements. Three working groups were formed: external systems, internal systems and services. This stakeholder involvement enriched the project while at the same time stimulating a transition in the construction sector. On the other hand, these partnerships and the constraints that resulted from working with existing products limited some of the design choices and thus the ambitions of the project.

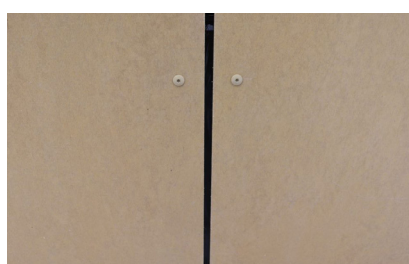

4.7.5. LESSONS LEARNED

BRIC

The assembly and the disassembly of BRIC provided precious feedback for the

Architectural consequences

Thinking about the architectural details needs to be integrated from the start, especially when the project uses reclaimed products.

Technical consequences

The quality of the materials play an important role. Materials must be of top quality. From a screw to a wooden cassette, increasing the quality increases the reuse potential of all the elements.

Preparing the execution plans in detail with a high degree of precision avoids inefficiencies during the execution in terms of time and cost.

The use of unprocessed, separable materials maximises the reuse potential and the capacity to adapt.

Simple, non-composite systems allow their subsequent reuse in other projects.

Upfront investment needed

The time spent on explaining the project to stakeholders and workers in the conception phases is effectively recovered in the execution phase. Vice-versa an unprepared execution phase has dramatic impacts on the planning and the budget.

Efficient use of nature

The choice of a bioclimatic design will lower the use of technology and thus the use of raw materials.

Simple technologies enable fast understanding of the technical aspects and promote better reuse.

BRIC is an educational module. A next step that will allow to scale up the project consists in optimising the time for assembly and disassembly, and focus on inventories and logistics.



GTB

Architectural consequences

GTB Lab facades are made of different materials. From an aesthetic point of view the idea was to illustrate the possibility to design different facade types. Two were made of glass - one of which is producing electricity with integrated PV strips - and two are made of wood and polycarbonate. The biggest design challenge was to provide architectural coherence while using many different materials with different properties and dimensions. And taking into consideration that elements also need to be exchangeable.

Technical consequences

Reducing the number of connections enabled fast assembly and disassembly of the GTB Lab module and its components. Standardising dimensions of the openings to fit the production line dimensions of the triple glass reduced the production waste of big triple glass panels for 95 %. Such design decisions can considerably reduce the cost of the systems used.

Multifunctionality at product level

The pilot project proved the importance to integrate building products with several functionalities.

The design maximises the use of natural light with high impact on both comfort and energy efficiency: two facades are using triple glass while the others and the roof are using translucent panels to diffuse natural light. Natural light has impact on energy use. It reduces the need for artificial light. Facades integrated in the GTB Lab serve several functions. The triple glass with integrated PV strips protects the space from direct sunlight and overheating, while generating energy. The triple heated glass provides thermal comfort.

Ease of use

In order to facilitate easy disassembly and reversibility, it is important to design readily demountable connections. The project successfully tested interlock connections and simply gravity connections. Intermediary elements between two components and systems provided high versatility and flexibility to space, systems and simple elements. Reducing the amount of mechanical connections made the transformation process easy: no bolts or screws to remove.

BIM as a circular tool

GTB Lab pilot illustrated that it is possible to automate the assessment of reversibility of buildings (developed by E. Durmisevic, UTwente) and in particular physical dependences between building elements by use of BIM.

REMs

BEYOND THE LIMITATION OF MODULARITY

The REMs demonstrated that reversible design can be practiced in building fairs.

Architectural consequences

The architectural team touched upon the sensitive subject of modularity and lack of identity. If designers are called to design grids and processes, they need to integrate variation, creative graphical layers, flexibility, and think “out of the box”

Technical consequences

Increased architectural flexibility combined with reusable modularity requires:

- reduction in module-size (reduced granularity / smaller pixels). However this increases complexity and reduces reliability because of an increased number of connections.
- add resilience in structures through over-dimensioning load bearing structures to ensure structural integrity at various load-scenarios

Scalability of modular architecture is high as only a small set of modules needs to be tested and approved, after which any construction size can be built.

The rigidity of the building can be achieved by introducing strategic connections.

Focus

Endless reversibility and adaptability can end up in endless designing. A workable approach is to limit the scenarios to two or three, such that relevant design adaptations can be introduced.

Reversibility is limited, even for a dedicated aluminum structure such as Octanorm. Structures will wear down. A maximum of 10 uses is anticipated by Gielissen.

Transformation Relocation

There was a learning curve: every assembly and disassembly is likely to be faster. The modularity combined with a well designed logistical system including transport can generate a highly efficient operational model for temporary set-ups. The strength of REMs lies in its storage and packing strategy.

It's all about objectives

Peoples' motivation is an important driver for making circular solutions happen. Results cannot be achieved if stakeholders do not understand why they are implementing reversible design. The time to build trust, understanding and engagement is critical for the success of circularity. Amongst all stakeholders, especially the builders, who feel responsible for end-results, are hesitant to try novel construction methods. Responsibilities for potential failures need to be addressed.

CRL

The Circular Retrofit Lab project highlights the need for synergies between activities within the construction industry, by combining different processes: **the design process, the collaboration process and the learning process.**

THE RIGHT SYSTEM IN THE RIGHT PLACE

In the daily reality of construction, taking into account the constraints of the building code and legal responsibilities, it is difficult to implement the most suitable systems in terms of reuse and reversibility. Today, a successful circular design solution should smartly assess and respond in a balanced and holistic way criteria such as: versatile plan layout, adaptable and upgradable solutions, demountable and reusable building kits, industrial partnerships as well as environmental and cost analyses. For example, for a system with a relatively low rate of change, a solution with lower adaptability or reuse potential might be acceptable, especially if the initial selection of materials results in a low total environmental life cycle impact.

Combining existing systems and material in an innovative way can generate circular solutions and leverage on existing markets and product comprehensibility.

Independence between systems is one of the keys to success. Similarly the ease and speed of use are crucial to making a solution appealing to the user.

More than technical performance, qualitative architecture, health aspects, user comfort (acoustics), energy performance, cost, fire safety and, heritage value are some of the important aspects that make a circular building livable, attractive and therefore a long-lasting asset. However some of the solution (e.g. membranes) are generating waste.

Technical consequences

Technical installations have a big impact on the reversibility of a building. Although a bigger upfront investment is required, drawing the technical units and circuits, such as ventilation units or heating systems for future transformation scenarios, will avoid their frequent replacement and allow the addition or removal of elements without generating waste.

A relatively small percentage of technical systems existing on the market incorporate reversible connections. Experienced contractors are necessary in order to implement these systems in a correct manner.

It's not only design

Although a large majority of the implemented systems in the Circular Retrofit Lab are developed to be demountable and reusable, their actual reuse and waste reduction potential can only be realised through the use of business models and Material Passports, and most importantly their management and maintenance during the project life.

ARE YOU KNOWLEDGEABLE ABOUT MATERIALS PASSPORTS?

5. DATA SHARING THROUGH MATERIALS PASSPORTS DEVELOPMENT

A close-up photograph of a corner in a wooden structure, likely a cabinet or shelving unit. The structure is made of plywood, with the layered edges of the sheets clearly visible. The wood has a light, natural tone. The lighting is soft, highlighting the texture of the wood and the precision of the joinery. The background is a plain, light-colored wall.

MATERIALS PASSPORTS ARE ELECTRONIC AND INTEROPERABLE DATA SETS THAT COLLECT CHARACTERISTICS OF MATERIALS AND ASSEMBLIES, ENABLING SUPPLIERS, DESIGNERS AND USERS TO GIVE THEM THE HIGHEST POSSIBLE VALUE AND GUIDE ALL TOWARDS MATERIAL LOOPS. © BAMB

Availability of information about the materials that are included in a product or construction is playing a major role in the circularity of a building. But the information management needs to be efficient. The pilot projects helped focus on the most practical aspects, such as expected lifetime of products, how materials and components can be demounted, reused or recycled, what the performance is over time, health aspects and sustainability of the raw materials, and the material capacity to keep their market value through the time.

Before recording information in the platform, REMs helped the team to understand what information was needed to assess the circularity of products whilst selecting them.

Once this data is collected on the Material Passport platform, more effective reversible building design solutions can be developed. Owners, designers, users, can anticipate future functional needs by both designing flexible buildings and leveraging on reused products and materials. Demountable, adaptable and reusable, no-waste solutions can increase the reversibility.

5.1. REMS: A PHYSICAL SUPPORT FOR TESTING DIGITAL PASSPORTS

As already stated, REMs is an interactive travelling exhibition of more than 70 products for circular buildings, and their digital passports. It offers tangible means to discover possibilities, advantages of passports, for professionals from the built environment.

A list of 5 criteria was used as a tool to quickly select the large amount of circular products to be displayed.

Criteria REMs selection	Parameter
Availability	On the market latest one year after end of travelling schedule (not include the economic feasibility of these products, nor the availability of materials in volumes required for larger construction projects)
Reversibility potential	Detachable from surroundings or non-polluting to surroundings it is permanently attached to
C2C certified	Bronze or higher not contain Banned List Chemicals and have a reutilisation score that in general is higher than industry average
Reutilisation potential	Above industry average levels of recycled input and recyclable output
Material health performance	No chemicals present as defined in the banned list declaration of C2C certified

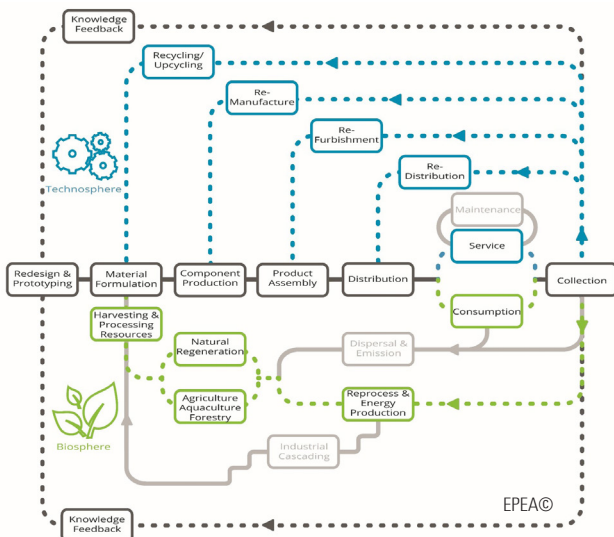
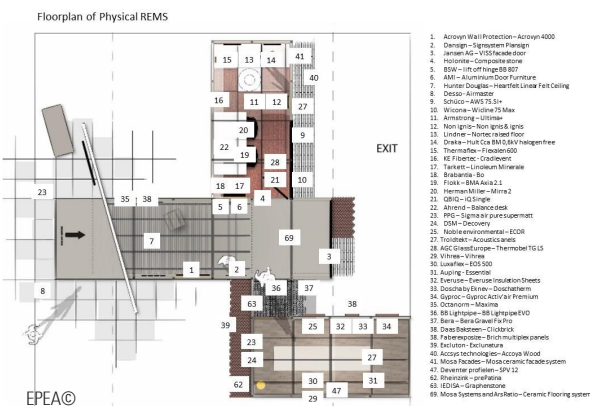

5.1.1. THE PLATFORM

Participants entered their product data on the platform with support from EPEA and the TUM. On the platform, the REMs pilot is listed as a building, the products are listed and product instances are linked to the building. Passports were made with a rich variety in levels of detail: some companies only entered a product name, others included detailed descriptions of circularity features. A set of minimally required questions ensured each passport had some information.



5.1.2. INTERACTION BETWEEN THE PLATFORM AND PHYSICAL MATERIALS

Once placed, each product received an individual business card with a QR code and a print on a birch panel with a number and an NFC-chip sticker. The QR code and the NFC chip triggered a personal mobile device (like android and apple smartphones) to open the link to the passport in the BAMB Material Passports platform. The Business cards all have the guest login to the BAMB platform on the backside, enabling visitors to log in and view the Material Passport corresponding to the scanned QR code or NFC chip.



“Finding 70+ manufacturers with products optimized for circularity was not the challenging part. Of course a lot of work, also to get the data. You need their cooperation. They need a return. We developed visual summaries in the first place for downstream users of the platform: architects, contractors. But the manufactures were probably even more excited about these summaries to use for future communication. The form of the passport is crucial for a wide adoption, and a standardized visual similar to what we developed is our recommendation. A next step in technology is the question what do we precisely want to show, how to automate the generation of such visual. ”
EPEA Team

Material Passports can play a role in selecting products during design with a high reuse and recyclability potential. They help prevent waste by making relevant information available at the time that re-use decisions need to be made. Material Passports can create synergies with products that have been optimised for re-use and reversibility, as these have high potentials for re-use, and are easy to reuse. Material Passports help select products and materials which are resource efficient, such as those reusing material and those with high re-use potential.

5.1.3. CONCLUSIONS

Several platform-related thresholds have been identified during REMs. For instance, navigation was at times long and difficult. QR codes or NFC chips had to be scanned before and after the manual login. The web pages were not always responsive available.

This setback was mitigated by the integration of visuals, showing passport information in a condensed and visually appealing way. The visualisations proved successful in informing participants about material health and reuse potentials.

The team realised that graphical explanations should be entered in line with the text. Drawings can provide information related to reversibility features of the products (Figure 76).

Data is important but the way it is presented and approached via the platform could help the users to choose the most reversible products and maximise the value of the materials they employ.

Use of common language, clarity of questions, limitation in the effort demanded by the users, prioritisation, practical information are key for a successful Material Passports tool. The platform has to provide intuitive experience and be self sufficient. The need for extra help and explanation should be limited.

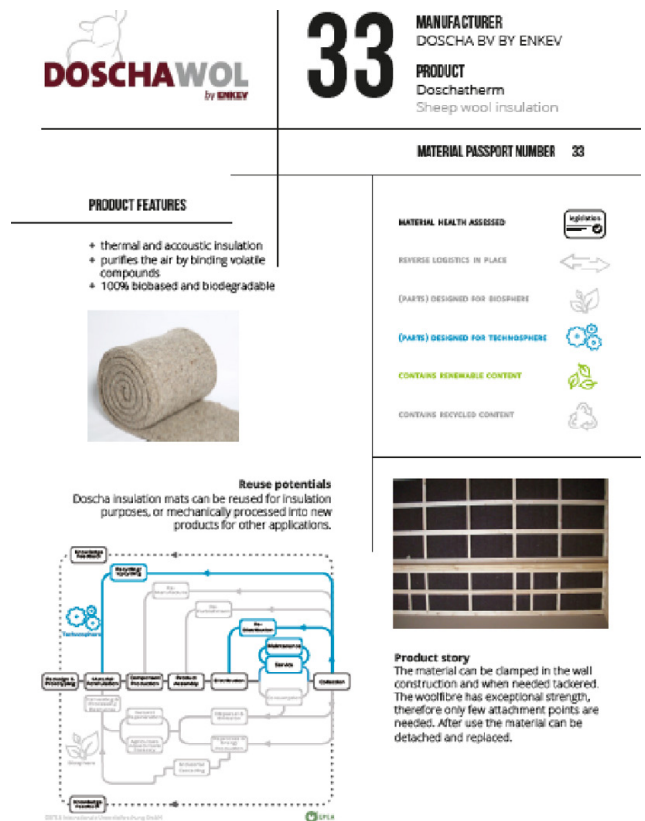

Figure 76: The visualisations of materials passports

EPEA©

5.2. DECENTRALISED OPEN INFORMATION

The development of the Circular Retrofit Lab provided interesting feedback for the further development of Materials Passports and their implementation in the design and construction process.

The team investigated the type of data and information useful in assessing environmental impacts of the construction and enabling efficient reuse of construction components. It provided feedback on the ways in which data can be effectively stored and transferred to achieve a more circular construction process.

Transparency, efficient data management The transformation processes that took place in the Circular Retrofit Lab and in the preparatory “experimentation lab” involved different teams to install, disassemble, reinstall internal wall systems, at three different moments in time. It highlighted the need to **transfer data** from one team to another in an effective way. A record on technical assembly and disassembly information will allow future owners, contractors and users to effectively make use of the reversibility and transformational capacity without creating waste.

For information management, rather than using the Material Passport platform, the CRL team gave preference to **a centralised solution** - an integrated use at the level of a BIM model- that ensures information transfer and direct access to. In the future, extended BIM model capacity will allow a direct link with the upcoming Circular Building Assessment tool through the development of a specific plug-in.

The downside of this centralised solution was the impossibility to transfer and link different projects. Solutions for a more collaborative process beyond the project’s boundary are needed.

“It will be crucial for the development of a Material Passport platform to include chronological (block chain) information on material characteristics and use together with the author and input date of the information, as to transparently and incorruptibly keep a record of the building information throughout the different phases of its life.” VUB team

The relationship between the digital information and physical systems and elements is important. In **situ accessibility** will give opportunity to all stakeholders to easily access information.

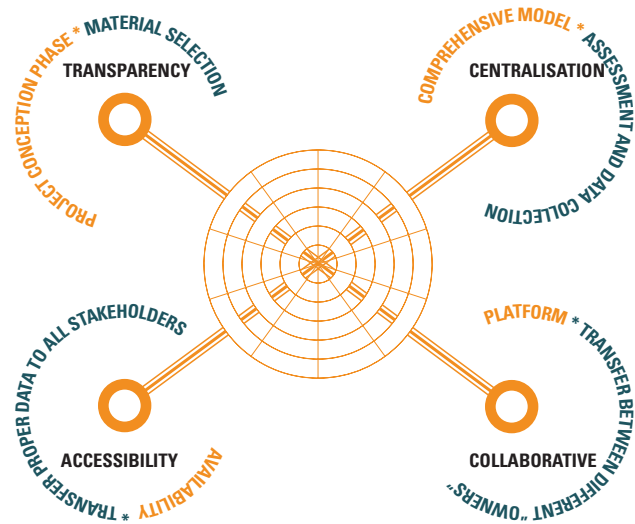

Figure 77: A Materials Passports Platform concept, based on the VUB team reflections

Three important pieces of information regarding the waste reduction within a building are highlighted:

- Reuse potential of materials
- Reversibility of the systems
- End-of-life treatment

Materials Passports could open repeated reuse opportunities for materials that end up as waste today. Materials Passports should be capable to integrate with accuracy information related to the performance and capacity of materials, during the lifespan of the building. This will allow product owners to continuously assess the current status and characteristics of their assets and update the initial certification.

When exchangeability of the systems and elements such as the facade panels and cladding panels of the CRL is foreseen, precise information about the dimensions and position of elements is necessary (see Figure 71 on page 70).

ARE YOU CONCERNED ABOUT THE ENVIRONMENTAL IMPACT?

6. CIRCULAR LIFE CYCLE ASSESSMENTS

AUTHORS: MIRKO FARNETANI AND FLAVIE LOWRES, BRE



CIRCULAR BUILDING ASSESSMENT IS A METHODOLOGY THAT COMPARES AND ASSESSES PRODUCT AND MATERIAL RESOURCE FLOWS DURING THE LIFE TIME OF A BUILT ASSET AND BEYOND. THIS METHOD IS BEING DEVELOPED INTO A PROTOTYPE ONLINE PLATFORM/ TOOL THAT CAN QUANTIFY AND COMPARE DESIGN APPROACHES, FOCUSING ON THE DIFFERENCE BETWEEN 'BUSINESS AS USUAL' VERSUS CIRCULAR BUILDING SCENARIOS. © BAMB

BRIC - CIRCULAR BUILDING ASSESSMENT (CBA)

6.1. BRIC - A CIRCULAR LCA

6.1.1. AKNOWLEDGEMENT

BAMB Circular Building Assessment, referred as CBA, is a methodology developed by BAMB partners, BRE and Sundahus. It compares and assesses product and material resource flows during the lifetime of a built asset and beyond. This method has been further developed into a prototype platform/tool that can quantify the circularity and reversibility of different design approaches thus making it possible to compare them, focusing on the differences between 'business as usual' versus circular and reversible building scenarios. These include reusing from the previous built environment, designing for future reuse via reversible building design, and the potential to transform, highlighting the corresponding environmental and economic net benefits.

6.1.2. BRIC- CIRCULAR BUILDING ASSESSMENT

This report details the Life Cycle Assessment (LCA) of the BAMB 2020 pilot project building Build Reversible In Conception (BRIC) with particular focus in designing for demountability (Reversible Building Design) and subsequent reuse of building parts over three life cycles.

This assessment accounts for the comparative environmental impact of BRIC over a study period of 60 years, where three buildings were built and demounted after a 20-year life cycle (see Figure 80).

Figure 80 explains the 60-year study period subdivided into 3-life-cycle circular design schedule:

- BRIC1 design Phase 1: built at Year 0 and demounted at Year 20.
- BRIC2 design Phase 2: built at Year 20 and demounted at Year 40.
- BRIC1 design Phase 3: built at Year 40 and disposed at Year 60.

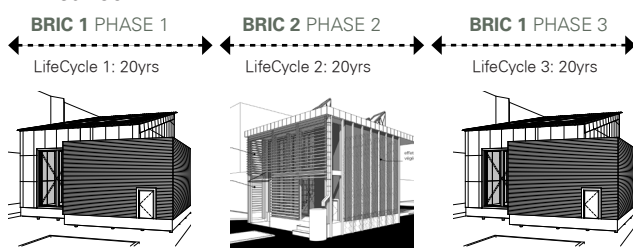

Figure 80: BRIC study period concept (KARBON Architecture).

The same design was used for Phases 1 and 3 and referred to as BRIC1. For Phase 2, the design was different from BRIC1. The BRIC building is therefore referred to as BRIC2. The aim of the BRIC pilot project was to apply in practice the Circular Economy principle of demountability and reuse of materials in each cycle.

The calculation methodology outlined in the standard **EN 15978:2011**⁷ was used to assess the environmental performance of BRIC.

6.1.3. ENVIRONMENTAL ASSESSMENT METHODOLOGY

A Life Cycle Assessment (LCA) study of the BRIC building was carried out. Results were provided against the Global Warming Potential (GWP, expressed in kg CO₂eq) indicator. The BRE Global Methodology For The Environmental Assessment Of Building Using EN 15978⁸ was used for the calculations. Modules A1 to A3, A4, A5, C2 and C4 were reported. No data was provided for module B (in-use stage) and no data was available for C1 and C3 – those modules were therefore excluded from the study.

6.1.4. BUILDING INFORMATION

System boundary

Study period

Three buildings were assessed over the 60-year study period. Each building was accounted over a life cycle of 20 years (see Figure 80, Figure 81):

LCA data source – Stage A1-A3

The datasets for the materials used in BRIC1 and BRIC2 were sourced fromecoinvent and representative of European dataset. The data were modelled in SimaPro⁹ using the BRE EN15804 PCR¹⁰.

Construction Stage data – Stage A4-A5

A4 module refers to the transport to site of each materials and A5 refers to the impacts related to the construction stage, i.e.: energy, water, wastes generated on site. The information used was sourced from BRE database.

In Use Stage assumptions – Stage B

This stage takes into considerations all impacts occurring during the use of the building, e.g.: the impact of taking

down, disposing of materials and their replacement, the maintenance of the materials (e.g.: cleaning) or any impact related to repairs of the building.

According to the information found in MMG2017/TOTEM ¹¹, it was decided the following:

B1, B2, B3, B5 were not considered (lack of available data)

B6 and B7 relate to the operational use of energy and water and were out of scope and omitted from the study

B4 was taken into consideration, but considering frequency of building remodeling and building element, no replacement occurred during any of the three 20-year life cycles for the element considered in the study.

End of Life Stage assumptions – stage C

The final processing of construction and demolition waste of building materials assumptions were taken from “Environmental profile of building elements” [update 2017].

Circular Design Schedule

The BRIC buildings were assessed over a study period of 60 years during which the buildings were deconstructed and remodelled every 20 years as explained in section 3.1.1. as much as possible, the same materials were reused from BRIC1 phase 1 to BRIC2 phase 2 and BRIC1 phase 3. however, new materials have been brought in to BRIC2 phase 2 as the design was different (see Figure 82, Figure 81). The analyses used Building Material End of Life allocation from MMG 2017.

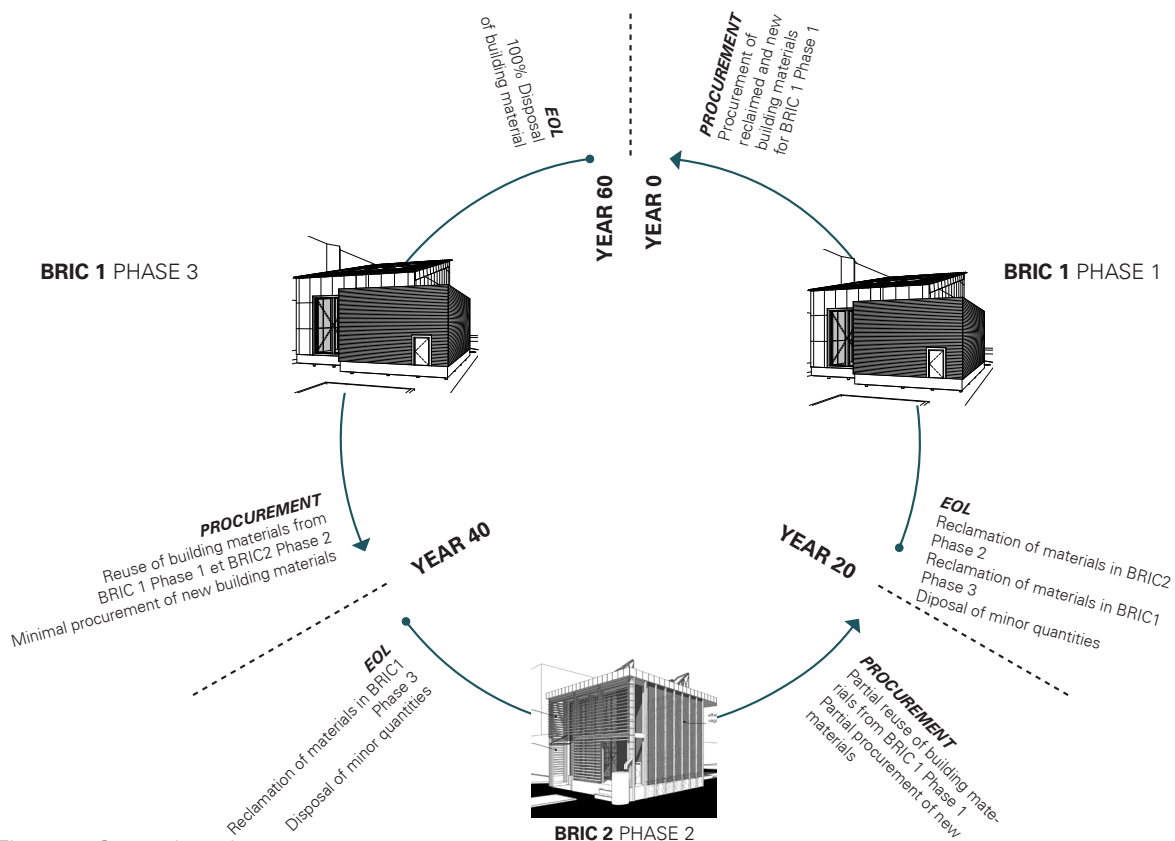

Figure 81: System boundary concept.

BRIC 1 PHASE 1			BRIC 2 PHASE 2			BRIC 1 PHASE 3		
Type of construction	Product Stage A1-A3	EoL Stage C	Type of construction	Product Stage A1-A3	EoL Stage C	Type of construction	Procurement	EoL Stage C
Ground floor 53.7 m ²	Timber Joist (Gites) 1/3 of joist was reclaimed All Materials Procured as new products	All Materials Not demounted 100% reused	Ground floor 53.7 m ²	All Materials 100% reused from BRIC1 Phase 1	All Materials Not demounted 100% reused	Ground floor 53.7 m ²	All Materials 100% reused from BRIC2 Phase 2	All Materials EoL according to MMG 2017
Timber Frame 1.6 m ³	All Materials Procured as new products	Recovered 100% in BRIC 1 Phase 3	Timber Frame 2.4 m ³	All Materials Procured as new products	All Materials EoL according to MMG 2017	Timber Frame 1.6 m ³	All Materials 100% reused from BRIC1 Phase 1	All Materials EoL according to MMG 2017
Mezzanine 12.7 m ²	All Materials Procured as new products	Recovered 100% for BRIC2 Phase 2 and BRIC 1 Phase 3	Mezzanine 26.30 m ²	Wood block floor 60% procured as new 40% reused from BRIC1 Phase 1 Compressed Mineral Wool Panel Ceiling 60% procure as new 40% reused from BRIC1 Phase 1 All the rest Materials Procured as new products	Wood block floor 60% EoL according to MMG 2017 40% reused from BRIC1 Phase 3 Compressed Mineral Wool Panel Ceiling 60% EoL according to MMG 2017 40% reused from BRIC1 Phase 3 All the rest Materials EoL according to MMG 2017	Mezzanine 12.7 m ²	All Materials 100% reused from BRIC1 Phase 1 or BRIC2 Phase 2	All Materials EoL according to MMG 2017
Pitched Roof 45.5 m ²	All Materials Procured as new products	Wood wool On BRIC1 Phase 3: 75% reused EoL: 25% of wood wool residues. When disassembling, the wool pane crumbled (2 types of wool fiber insulation boards, one is very short and dusty, the other very long). Waterproof Membrane On BRIC1 Phase 3: 100% recovered for testing, but very sceptic about reuse potential. OSB BRIC1 Phase 3: 100% reused	N/A	N/A	N/A	Pitched Roof 45.5 m ²	Wood wool From BRIC1 Phase1: 75% reused 25% procured as new Waterproof Membrane From BRIC1 Phase 1: 100% recovered for testing, but very sceptic about reuse potential. OSB From BRIC1 Phase 1: 100% reused	All Materials EoL according to MMG 2017
Pitched Roof Roof covering 45.5 m ²	All Materials 100% reclaimed	After 20 years reclaimed galvanised metal sheet could be assumed to be at the end of Service Life All Materials 100% EoL according to MMG 2017	N/A	N/A	N/A	Pitched Roof Roof covering 45.5 m ²	All Materials 100% procured as new	All Materials EoL according to MMG 2017
Flat Roof 13.7 m ²	All Materials Procured as new products	EPDM EoL according to MMG 2017 After 20 years, EPDM could be assumed to be at the end of Service Life also due to the fact of likely damages during demount-ing. BRIC2 Phase 2 has a flat roof and so new EPDM will be purchased. All remaining Materials Recovered at 100% for BRIC1 Phase 3.	Flat Roof 63.36 m ²	All Materials Procured as new products	All Materials EoL according to MMG 2017	Flat Roof 13.7 m ²	All Materials 100% procured as new	All Materials EoL according to MMG 2017
External Wall Type 1A 60.2 m ²	All Materials Procured as new products	Compressed Mineral Wool Panel 10% of the panels are considered as non-usable, to not be used/reinstalled on the facade. The rest will be installed in BRIC2 Phase 2 Batten 100% reused Wall constructions (caissons) 30% of the wall constructions will not be re-installed in BRIC2 Phase 2 (25 non-standardised wall constructions, adapted to the slope of the slanted roof). Fibertech panels can be used for BRIC1 Phase 3. Panels are not considered waste, they are kept. Cellulose 95% reused 5% of the cellulose residues were not recovered (via vacuum cleaner). These flakes in the form of dust are volatile.	External Wall Type 1A 32.99 m ²	Compressed Mineral Wool Panel 100% Reused from BRIC1 Phase 1 Batten 100% reused Wall constructions (caissons) 100% reused Cellulose 100% reused	Compressed Mineral Wool Panel 10% of the panels are considered as non-usable, to not be used/reinstalled on the facade. The rest will be installed in BRIC1 Phase 3 Batten 100% reused Wall constructions (caissons) 100% reused Cellulose 95% reused 5% of the cellulose residues were not recovered (via vacuum cleaner). These flakes in the form of dust are volatile.	External Wall Type 1A 60.2 m ²	Compressed Mineral Wool Panel 30 m ² Reused from BRIC2 Phase 2 21 m ² Reused from BRIC1 Phase 1 10 m ² Procured as new products Batten 100% reused Wall constructions (caissons) 30% of the wall constructions re-installed from BRIC2 Phase 2 (25 non-standardised wall constructions, adapted to the slope of the slanted roof). Fibertech panels can be used for BRIC1 Phase 3. The remain reused from BRIC2 Phase 2. Cellulose 95% reused 5% procured as new products	All Materials EoL according to MMG 2017

External Wall Type 1B 31.1 m ²	All Materials Procured as new products	Compressed Mineral Wool Panel 10% of the panels are considered as non-usable, to not be used/reinstalled on the facade. The rest will be installed in BRIC2 Phase 2. Batten 100% reused Wall constructions (caissons) 30% of the wall constructions will not be re-installed in BRIC2 Phase 2 (25 non-standardised wall constructions, adapted to the slope of the slanted roof). Fibertech panels can be used for BRIC1 Phase 3. Panels are not considered waste, they are kept. Cellulose 95% reused 5% of the cellulose residues were not recovered (via vacuum cleaner). These flakes in the form of dust are volatile.	External Wall Type 1B 33.81 m ²	Compressed Mineral Wool Panel 6 m ² procured as new 28 m ² Reused from BRIC1 Phase 1 Batten 100% reused Wall constructions (caissons) 22 m ² (66%) Reused from BRIC1 Phase 1 12 m ² (34%) procured as new Cellulose 90% reused from BRIC1 Phase 1 10% procured as new	Compressed Mineral Wool Panel 10% of the panels are considered as non-usable, to not be used/reinstalled on the facade. The rest will be installed in BRIC1 Phase 3 Batten 100% reused Wall constructions (caissons) 22 m ² (66%) Reused in BRIC1 Phase 1 12 m ² (34%) EoL MMG 2017 Cellulose 95% reused 5% of the cellulose residues were not recovered (via vacuum cleaner). These flakes in the form of dust are volatile.	External Wall Type 1B 31.1 m ²	Compressed Mineral Wool Panel 6 m ² procured as new 28 m ² Reused from BRIC1 Phase 1 Batten 100% reused Wall constructions (caissons) 22 m ² (66%) Reused from BRIC2 Phase 2 12 m ² (34%) Reused from BRIC1 Phase 1 Cellulose 100% reused from BRIC1 Phase 1	All Materials EoL according to MMG 2017
External Wall Type 1B Mur_Ext_1Bis Clay Plaster Finish 31.1 m ²	All Materials Procured as new products	The support membranes of the plaster (reed cane and linen fabric) are not reusable. They were broken and / or torn apart. Membranes are fragile elements. This loss was predictable. These membranes are bio-sourced and compostable materials. All Materials EoL according to MMG 2017	External Wall Type 1B Mur_Ext_1Bis Clay Plaster Finish 33.81 m ²	All Materials Procured as new products	The support membranes of the plaster (reed cane and linen fabric) are not reusable. They were broken and / or torn apart. Membranes are fragile elements. This loss was predictable. These membranes are bio-sourced and compostable materials. All Materials EoL according to MMG 2017	External Wall Type 1B Mur_Ext_1Bis Clay Plaster Finish 31.1 m ²	All Materials Procured as new products	All Materials Procured as new products The support membranes of the plaster (reed cane and linen fabric) are not reusable. They were broken and / or torn apart. Membranes are fragile elements. This loss was predictable. These membranes are bio-sourced and compostable materials. All Materials EoL according to MMG 2017
External Wall Type 2 31.1 m ² (cedar cladding)	All Materials Procured as new products Cedar Cladding procured as reclaimed material.	Cedar Cladding 100% EoL according to MMG 2017 All remaining Materials 100% reused in BRIC2 Phase 2	External Wall Type 2 32.79 m ² (cedar cladding)	Cedar Cladding 100% Procured as Reclaimed (not from BRIC1 Phase 1). All remaining Materials 5% procured as new 95% reused from BRIC1 Phase 1	Cedar Cladding 100% EoL according to MMG 2017 All remaining Materials 5% EoL according to MMG 2017 95% reused in BRIC1 Phase 3	External Wall Type 2 31.1 m ² (cedar cladding)	Cedar Cladding 100% Procured as Reclaimed (not from BRIC2 Phase 2). All remaining Materials 100% reused from BRIC Phase 2	All Materials 100% EoL according to MMG 2017
Windows Frame	All Materials 100% reclaimed	50% of the chassis are in bad condition. This rate concerns the installed chassis being reused. All Materials 50% reused in BRIC1 Phase 3	Windows Frame	All Materials Procured as new products	All Materials EoL according to MMG 2017	Windows Frame	All Materials 50% reused from BRIC1 Phase 1 50% procured as new	All Materials EoL according to MMG 2017
Windows Double Glazed Unit	All Materials Procured as new products	All Materials EoL according to MMG 2017	Windows Double Glazed Unit	All Materials Procured as new products	All Materials EoL according to MMG 2017	Windows Double Glazed Unit	All Materials Procured as new products	All Materials EoL according to MMG 2017
N/A	N/A	N/A	Façade Shading Timber 0.3 m ³	All Materials Procured as new products	All Materials EoL according to MMG 2017	N/A	N/A	N/A

Figure 82: Circular Design Schedule

6.1.5. ANALYSIS

Introduction

The analysis was carried out by comparing the results between the three BRIC buildings where a circular design approach was adopted. The results are presented in accordance with EN 15978 Stages analysis (see Figure 83, Figure 84) and cumulative impact over time analysis (see Figure 85).

EN 15978 Stages Analysis

Figure 83 shows the results obtained from Circular Design Measures for BRIC1 Phase 1, BRIC2 Phase 2 and BRIC1 Phase 3 for stages A1 to A3, A4 and A5, B and C.

Figure 84 shows the results obtained from NON-Circular Design Measures for BRIC1 Phase 1, BRIC2 Phase 2 and BRIC1 Phase 3 for stages A1 to A3, A4 and A5, B and C. The same comparison between BRIC Non-Circular Design and BRIC Circular Design was applied for analysing the cumulative impact over time (see Figure 85).

Comparing with the BRIC Non-Circular Design, the BRIC Circular Design approach shows the clear benefit of perpetual reclamation (see Figure 85). In fact, Figure 3 shows that the impact of Stage A1-A3 decrease from BRIC1 Phase 1 to BRIC2 Phase 2 and again to BRIC1 Phase 3. The same trend was found in the Stage A4-A5; in this case it was assumed that no transport was considered for reclaimed building element, because the activities of building, demounting, storing and remounting were in the same site. Stage C also shows a descending impact from BRIC1 Phase 1 and BRIC2 phase 2 (see Figure 83). However, stage C increases at BRIC1 Phase 3. This is because it was assumed that BRIC1 phase 3 would be demolished at the end of its life. The Circular Design strategy demonstrated to achieve approximately 41,770 kg CO₂eq savings compared to a non-circular approach (see Figure 85).

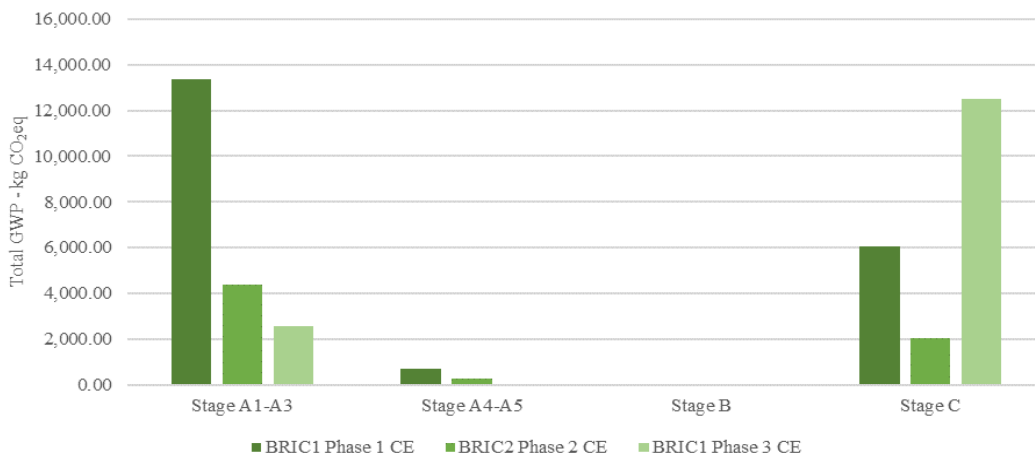

Figure 83: Circular Design Measures

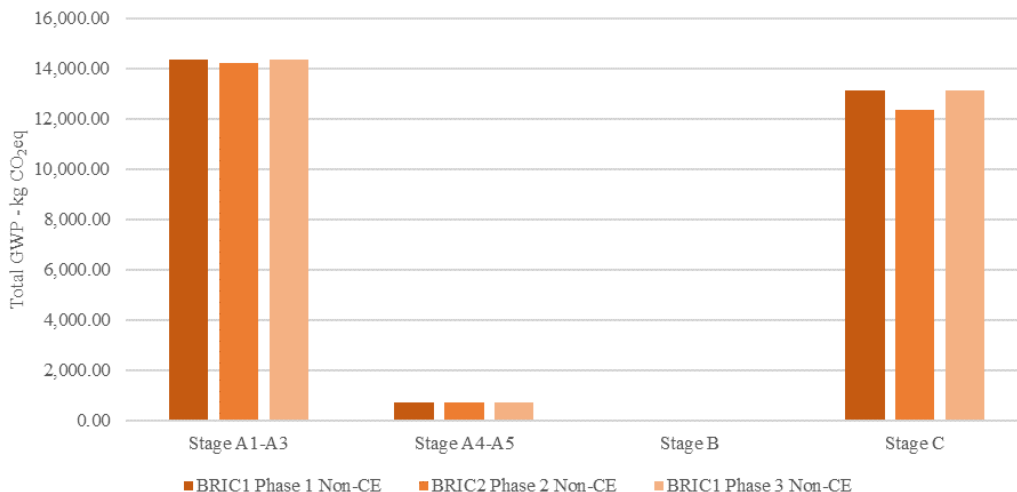

Figure 84: Non Circular Design Measures

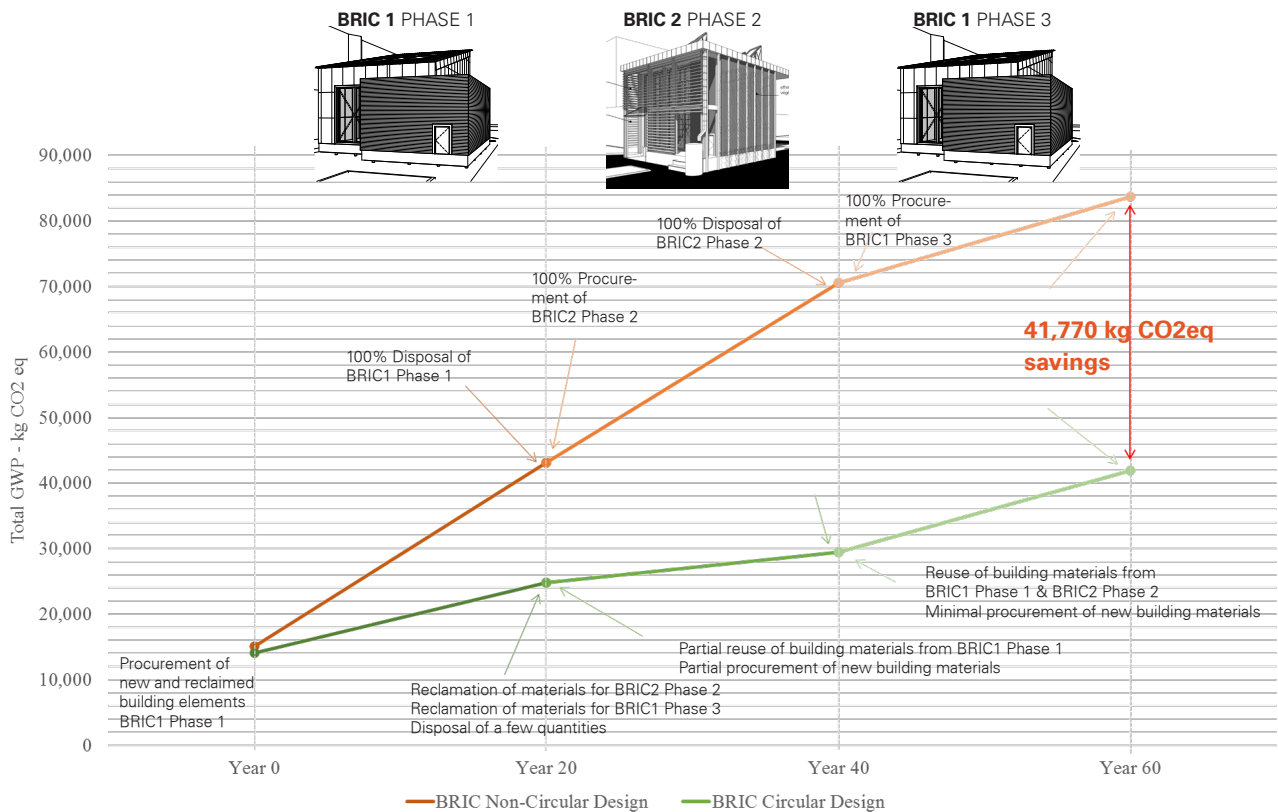

Figure 85: Cumulative Impact over time of BRIC Circular Design vs BRIC Non-Circular Design

6.1.6. CONCLUSIONS

The BRIC building pilot project was conceived adopting circular design principles in order to allow perpetual reclamation of building elements. Building parts were designed to be demounted at the end of life and of course to be easily reassembled in the following life cycles.

To demonstrate the benefit of circular building design and perpetual reclamation, the BRIC building was assessed over a study period of 60 years through a 3-phase remodelling each 20 years, the building reconfiguration was as per the following:

- BRIC1 Phase 1 was built at Year 0 and demounted at Year 20.
- BRIC2 Phase 2 was built at Year 20 and demounted at Year 40.
- BRIC1 Phase 3 was built at Year 40 and disposed at Year 60.

BRIC 1 Phase 1 and BRIC1 Phase 3 were identical, whereas BRIC2 Phase 2 was completely remodelled (see Figure 80). Hence, two analyses were carried out:

- EN 15978 Stages Analysis: Circular Design vs Non-Circular Design
- Cumulative Impact Over Time Analysis: Circular Design vs Non-Circular Design

The first analysis demonstrated that the Circular Design generated a lower GWP emissions compared to the BRIC Non-Circular Design. The effect of perpetual reclamation was illustrated in Figure 82 opposed to the results shown in Figure 84.

The second analysis concluded that the cumulative impact over a 60-year achieved approximately 41,770 kg CO₂eq saving by adopting Circular Design instead of Non-Circular. In summary, Circular Design principles were found beneficial in reducing greenhouse gases. Additionally, Circular Design principles of building elements also leads to a minimisation of natural resource.

GTB LAB



6.2. ENVIRONMENTAL ASSESSMENT METHODOLOGY DEVELOPED BY VITO (PROTOTYPING PHASE)

The GTB Lab and the CRL environmental assessment realised during the prototyping phase used a methodology currently under development, developed by VITO, one of the BAMB project partners. Slight modifications have been brought within the Product Environmental Footprint (PEF) formulas for each life cycle stage of the environmental and economic assessment.

Module D (see PEF) concerning benefits or loads due to (future) recycling/reuse/energy recovery is already taken into account in other modules. The modification integrates parameters related to recyclable or reusable materials.

6.1.7. GTB LAB PROFILE

An analysis was performed of two metal profiles with the same dimensions 0.08x0.08x 0.0025m:

- the GTB Lab reversible building profiles made by galvanized steel with stainless steel reusable connections to be deconstructed, moved and rebuilt after each transformation and recycled at the end of life, and
- a conventional square building profile made of galvanized steel with welded connections that will be demolished after each transformation, recycled and replaced with a new one.

It uses multiple scenarios based on three transformation cases: extreme, realistic and conservative scenarios, each associated with a rate of change of 7, 10 and 20 years over a lifetime of 100 years. The assessment uses the circular footprint formula in the extreme, realistic and conservative scenarios for climate change impacts. It uses a reuse and recycling allocation factor of 0.5, based on the assumption that in a circular economy, supplier and user share equally reuse and recycling burdens.

First partial results highlight the following aspects:

- Due to the reuse of materials at the recycle at the end of life, GTB Lab has higher substitution benefits in the use and the disposal stage (B1-B5, C1-C4),
- The benefits of the reuse are relevant on the long-term.
- The profile is in R&D phase. This explains why in the product stage impacts for GTB Lab are higher than the baseline case. However, there are high margins for the material use optimisation with improvement potential for environmental performances (A1-A5).

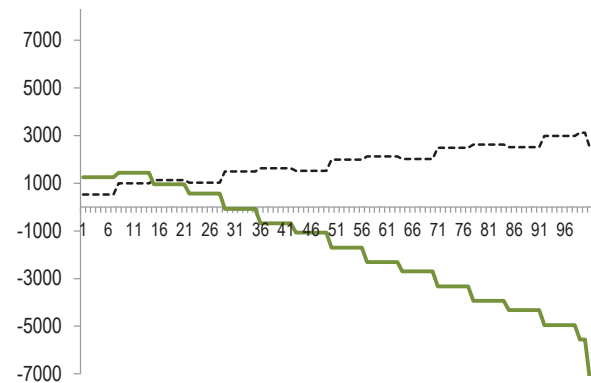

Figure 86: Climate change impact (100 yrs) for extreme scenario, 1 transf. every 7 yrs

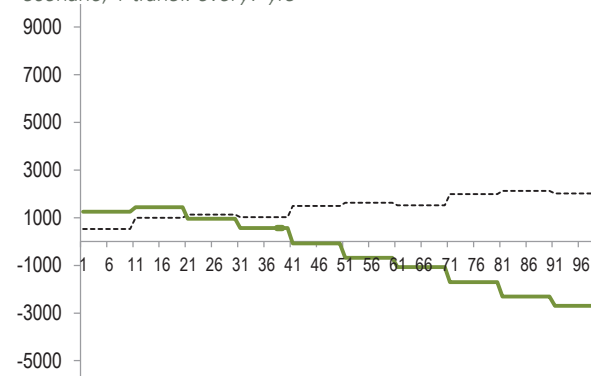

Figure 87: Climate change impact (100 yrs) for realistic scenario 1 transf. every 10 yrs

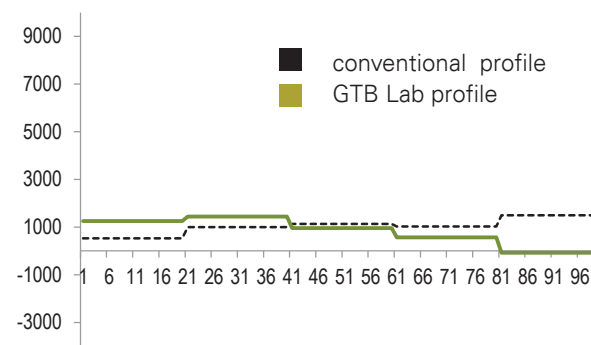

Figure 88: Climate change impact (100 yrs) for conservative scenario 1 transf. every 20yrs

CRL

6.2.1. CRL INTERIOR WALLS

The following transformation scenarios and technical solutions have been assessed:

Scenario 1 - interior wall - Yearly transformations

- Baseline gypsum cardboard with metal stud on both sides (t=0.012m)- no reuse
- Geberit GIS
- Systimber

The prototypes have minimal impacts especially in the maintenance and replacement scenarios compared to the baseline design.

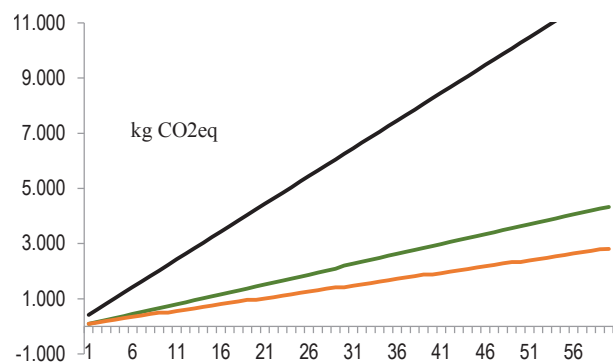

Figure 89: Environmental impacts per m², yearly transformation

Scenario 2 - Technical interior wall - Transformations every 10 years

- Baseline gypsum cardboard with metal stud- double plasterboard on one side (t=0.019m)
- Geberit GIS

Geberit avoids a large portion of the maintenance, replacement and refurbishment due to a reversible design. The avoided impacts in the product stage are due to the reduced extraction of virgin materials.

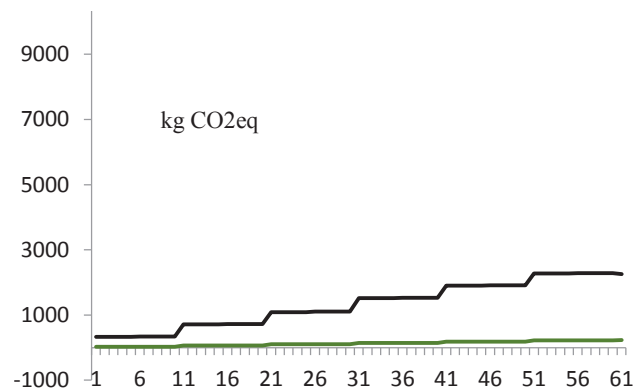

Figure 90: Environmental impact per m² Decennial transformation

Scenario 3 - Partition wall - Transformations every 15 years

- Baseline (idem Scenario 2)
- Geberit GIS
- Systimber
- Saint-Gobain Group

The prototypes have minimal impacts especially in the maintenance and replacement scenario compared to the baseline design. However, P2 and P5 are better placed for lower transformation rates.

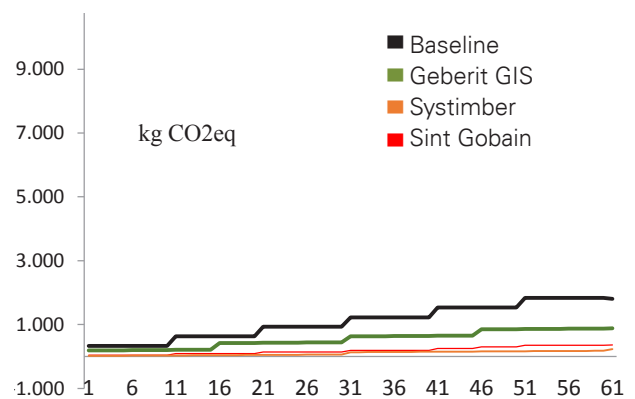

Figure 91: Environmental impact per m² transformation every 15yrs

REMs

6.3. REMS WASTE REDUCTION

To estimate the waste reduction potential of the REMs the EPEA team together with the designers made a simple with two alternative scenario's.

Scenario	% reuse	Reuse description
REMs	99%	All components are reusable. Carpeting may have to be cut to size or replaced, hence the 1% waste.
Standard business fair exhibition	15-20%	Most components are discarded apart from the products on display and special exhibition elements.
Standard travelling exhibition	25-50% reuse	Main construction elements may be reused 2-4 times, requiring new finishing each time. Standard travelling exhibitions wear down fast and for each instalment necessary reparations and replacements for walls and floors are likely

The REMs have an estimated waste reduction potential of 50-85% depending on the comparison. All components can be dismantled, packed for transport, and reinstalled in a new location. Gielissen estimates the maximum number of reinstallments is ten, before construction elements and wall start to have to be replaced

For each instalment approximately 50% of the carpets is reused. If you measure the percentage of the number of components reused it would equal to $100 - (0,5 * 1 / 70) = 99,3\%$ is reused.

6.4. EXCEEDING EXPECTATIONS

In terms of waste prevention, the disassembly of BRIC 1 was even more successful than anticipated in the CBA hypothesis. **Only 3,5 m³ of waste were generated.** More materials will be reused than expected.



Figure 92: Disassembly of BRIC 1; (photo Karbon)

ARE YOU READY TO CHANGE YOUR BUSINESS MODELS?

7. BUSINESS MODELS



"TO ENABLE RE-USE, REPAIR AND CIRCULAR MATERIAL FLOWS IN INDUSTRIAL SYMBIOSIS WE NEED NEW WAYS TO CALCULATE AND USE THE FINANCIAL ADVANTAGES OF A CIRCULAR BUILDING SECTOR. VARIABLES LIKE OWNERSHIP, TRANSACTIONS, FORMER EXTERNALITIES AND TIMESCALES COULD NEED NEW APPROACHES TO SUPPORT THE TRANSITION TOWARDS A CIRCULAR ECONOMY." © BAMB

7.1. BAMB PILOTS WORKING WITH NEW MARKET PLAYERS AND EXPLORING NEW BUSINESS MODELS

7.1.1. INDUSTRY TRANSFORMATION

Challenges

Currently, the construction industry not only has a negative impact on the environment, it also fails to meet the needs of a growing number of user segments. Access to the building stock has become a societal and spatial challenge. Suitable solutions to cope with the expected future growth and density are still lacking.

Technological opportunities

Today, the digital technology breakthrough is transforming more and more sectors. There is an increasing shift towards services, away from traditional tangible products that require hard infrastructure and traditional mass production chains. This shift in paradigm, from product- to service-based business models positions the user in the centre of the innovation. It takes into account the transformation in user behaviour and in revenue stream models. Many sectors have been changing, starting in the mid-nineties (telecom and banking in Asia), accelerated in the mid 2000s by the Internet's development (music industry, procurement and banking in Europe), and scaled up with the latest developments in social media and ubiquitous connectivity (mobility, tourism, health, insurance...), several major industries reshaped/ are reshaping their business models and have become part of a worldwide digital transformation (see Figure

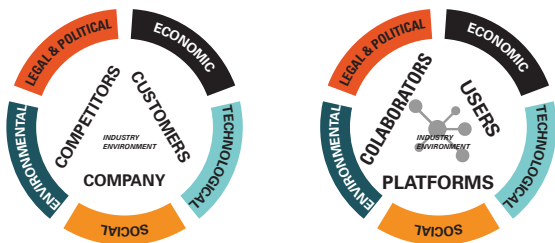

Figure 93: A scenario for industry transformation

93). Although some innovative business models have already been tested on the market, construction industry is still at the beginning of the digitalisation journey.

Web 2.0

SOCIAL NETWORKING	INTERACTION ORIENTATION	CUSTOMISATION PERSONALISATION	USER ADDED VALUE
Customer power	Customer centrality	Personal, group, social customisation	User generated content
Social identity	Customer response		User-generated creativity
Virtual word of mouth	Interaction configuration		User-generated innovation
Social trust	Cooperative value generation		User-generated revenue/ contacts

Figure 94: Four-factor model Web 2.0 developed by B. Wirtz et al.

The Internet and the digital tools of the WEB 2.0 are offering a higher degree of convenience and opportunities that could benefit both cities and communities (public and private) to shape easier environmental and user-friendly solutions. Better, more affordable and flexible buildings can be realised by leveraging the digital capabilities. "Interaction, customisation, user-added value and social networking " are participating to create valuable circular solutions (see Figure 94).

Moreover, human activities tend to move in "anytime", "anywhere", and "ubiquitous" space that enables businesses to reach a maximum number of users with customised real-time solutions (Figure 95 on page 113).

Considerations and advantages of these virtual experiences and trends should be integrated in development of digital tools for effective sustainable solutions of the future.

In this context, the pilot projects explore concrete leads by working with innovative market players (e.g. GTB Lab, CRL), making use of interactive digital tools (e.g. REMs) and seeking to meet multiple changing needs of users.

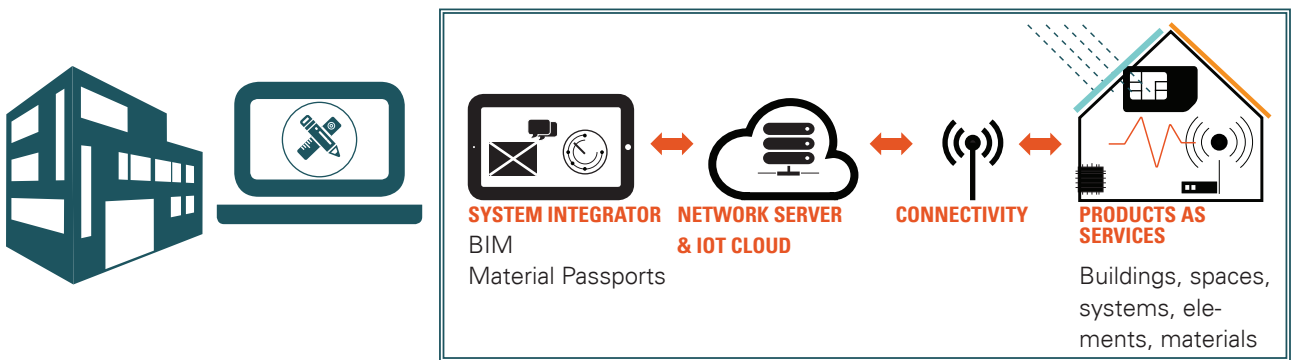
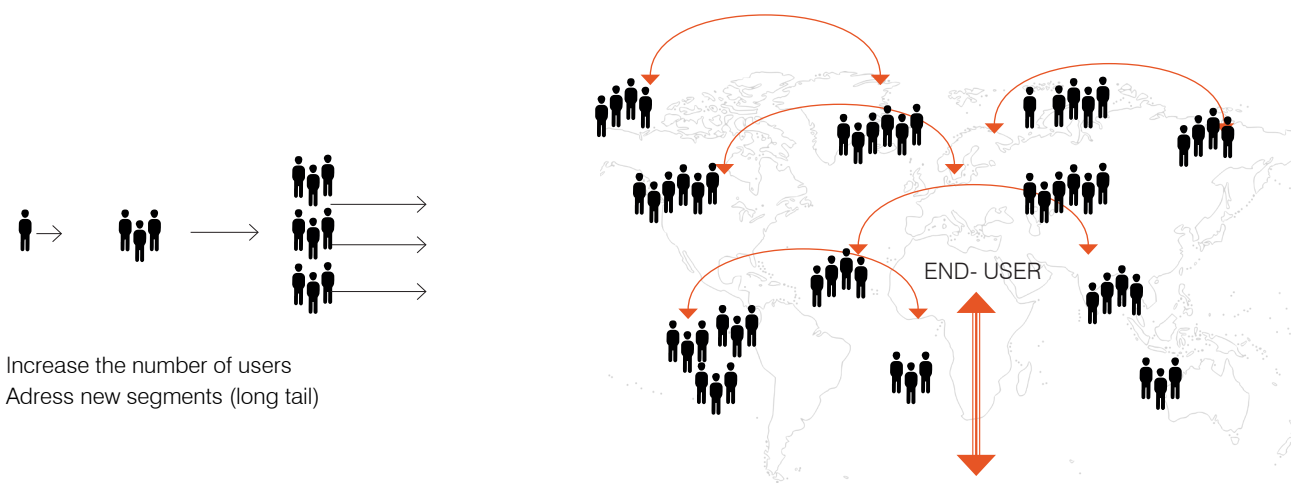

TRADITIONAL PHYSICAL	INFORMATIONAL	TRANSCENSION AND INTEGRATION OF PLACE AND SPACE	U-SPACE creates value and changes patterns through the following:
Physical constructions and products	Computer added design, technical data base, etc.	Ubiquitous network Physical and informational are fully integrated.	<ul style="list-style-type: none"> • The use of real-time spatial solutions increases the building's re-use potential and its transformation capacity. • Removing temporal and spatial physical interactions enhances efficiency and reduces waste, for instance through synchronisation between users' needs and availability of space, readiness of exchangeable elements... • Convenience is increased through new services that replace hard wasteful transformation of the buildings • Amplification of the user's experience; give the possibility of users to fast adapt their building environment.
<p><i>Figure 95: DIGITAL TRANSFORMATION</i> Adaptation of concepts after Jelassi and Porter 2014 and 2015</p>			

7.1.2. BUSINESS TRANSFORMATION

In a society and industry which redefines its modus operandi, new emerging business opportunities and models are developing.

A new kind of entrepreneurship is emerging, recognising business opportunities and formulating new business models, raising money and attracting new customers. In this context, Juunoo's adaptable interior systems that are easy to implement, were tested as part of the Circular Retrofit Lab. The Juunoo start-up developed a circular wall solution which "is not demolished at the end of its 'life', but disassembled and replaced as a next wall". Their unique selling point is focusing on: 100% reusable, 1-day placement, cheap and dust-free.

The initial contract that is negotiated when first buying the walls includes a sell-back price, ensuring take-back when the walls are no longer required. Moreover, a price reduction of 20% is included in the pricing formula to account for this buy-and-sell-back process. More qualitative materials are necessary for the product to be reversible and avoid damage.

ODS, one of the key stakeholders of the GTB Lab, is a manufacturer that provides all-in solutions in steel windows, doors and curtain walls.

Interested in extending the value of their products beyond their current life span, ODS wishes to keep the ownership of its products and recover them once the users need to transform their buildings.

Moreover, the company seeks to broaden their market and to address segments of users and customers interested in temporary solutions.

ODS created a harvesting platform, where architects can check available materials and integrate them into their design. The development of the GTB Lab helped ODS to improve this new value proposition for customers and architects and strengthen their business models. Developing products that are more adaptable and exchangeable is key.

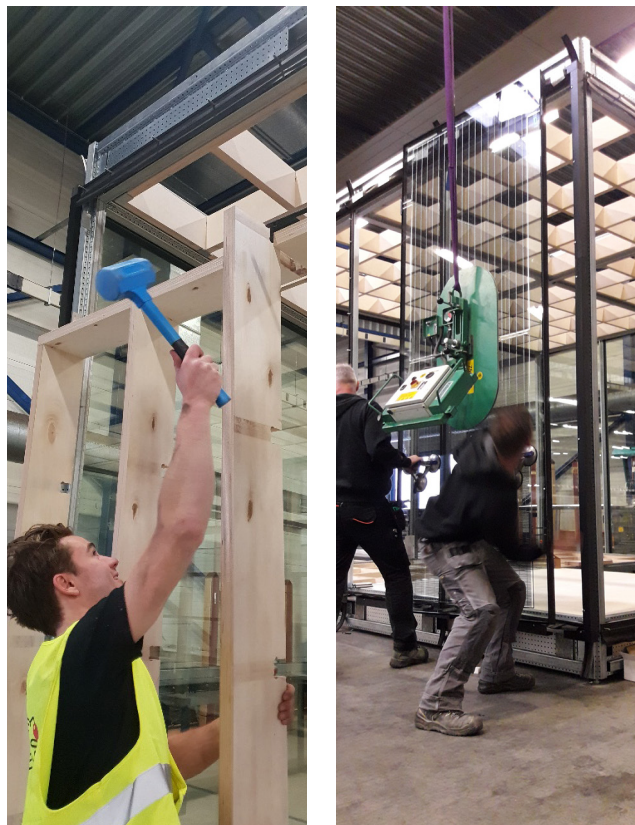

Figure 96: ODS worked together with GTB Lab to test the Reversible Building Design

7.1.3. WHAT'S NEXT?

Proving that a business model can work at small scale is not sufficient. The challenge resides in scaling up the models. An approach combining long term objectives with short term opportunities should be considered (e.g. harvesting strategies — long term vision, vs. short term profitability etc)

OBJECTIVES

Access to the market, for new products and services that make the supply in construction less static

A significant reduction in the environmental impact of buildings to mitigate climate change and the depletion of natural raw materials.

Open and efficient collaboration between all stakeholders involved in product and/or building life-cycle.

Short supply chains; Innovative circular systems and products

Share of vacant, new and existing buildings, reduce inventories of materials by using buildings as shared stocks, logistics

Revenue redistribution, new players, new ecosystems, synergies with other industries.

BUSINESS INNOVATION

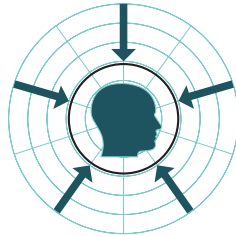

USER NEEDS
Needs change often during the course of a lifetime and through various phases of life, while the built environment is built in a rather static way.

CUSTOMISATION

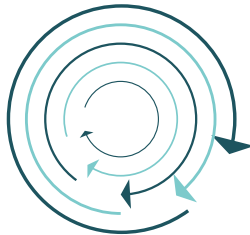

ENVIRONMENTAL OBJECTIVES
Close loops to cope with the scarcity of resources and surplus of waste in construction industry.

CLOSED ENVIRONMENTAL LOOPS



COMPLEMENTARITY
Identify synergies and partners that can respond to both changes in user needs and environmental objectives.

COLLABORATION ECOSYSTEM

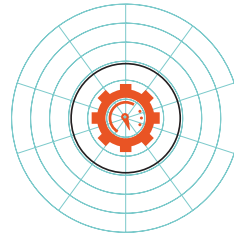

EFFICIENCY
Lean, agile... or any other method. To achieve close loops there is a need for effective and efficient operations.

EFFICIENT OPERATIONS

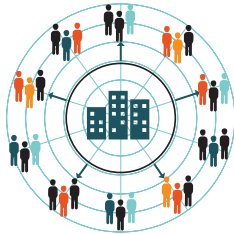

MAXIMISE VALUE

BUILDING- A SHARED ASSET

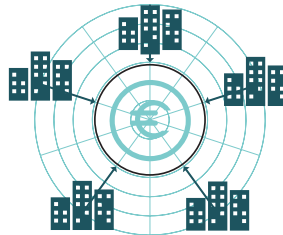

COSTS AND REVENUES

Sharing economy
Leasing
Asses other pricing models
Pay per use, freemium, bait and hook

TOOLS



Design for re-purposing and for optimal user experience:

Circular Building Assessment Tool (CBA)

Standards and policies for more qualitative buildings and materials, flexible spaces, easy maintenance, convenience

Use digitalisation as an enabler.
Materials passports platforms, BIM model.

Integrating efficiently reclaimed materials, as well as systems that enable swift and easy assembly-disassembly (e.g. kit of parts, standardisation and prefabrication).

FINANCE
New financial decentralised model, crowd-funding, partnerships, ventures.

7.2. WHAT WE LEARNED FROM PROTOTYPING- LIFE CYCLE COST (LCC)

Each innovation strategy adopted by BAMB pilots is potentially subject to the development of new business models. The learning from pilot prototyping (detailed in report D13) fed into another work package (WP5A2) “New business models based on reverse logistics and circular value chains in buildings”. It explored the interactions between the development of the pilots projects and the emergence of new building models supporting circularity. Notably, aspects such as ownership transfer, leasing versus purchasing, and changes in the primary activity value chain have been considered by the pilot project teams during the prototyping.

The GTB Lab team stressed the importance of making circular products competitive through cost reduction and by maintaining a higher value of materials for longer. Identified strategies are pointing out different key aspects such as the optimisation of production process, the rethinking of the logistic strategy, and ownership transformation based on the take back concept.

In the case of the CRL, the stakeholders involved in the prototyping process analysed the financial sustainability of developing circular products and buildings during the workshops (described on page 117). Making use of their experience, the contractor in charge of the pilot project, Group Van Roey, identified possible win-win scenarios for different stakeholders in the value network:

- for the users or owners, circular buildings are likely to improve the quality, maintenance and comfort
- for the investors or owners, the functional and spatial reversibility is likely to facilitate future transformations and therefore reduce the risk of uncertain future utilisation.

Moreover, if the investors remain the owner of the building over a certain duration, reversibility reduces the operational costs. The team identified a growing interest from engineering offices, product manufacturers, general contractors, etc. to learn how circular buildings may create new business opportunities.

Based on the workshops’ results, VITO (as part of WP5A2) tested a financial model which takes into consideration benefits from several financial life cycles, inherent to the cost of circular solution. The tested model uses multiple scenarios based on three transformation cases related to the three types of interior walls considered for the CRL, each associated with a different rate of change: yearly, once every 10 years or once every 15 years over a lifetime of 60 years.

Scenario 1 compares both the P1 Geberit GIS and the P5

Systimber wall systems with the a non-reusable baseline gypsum cardboard with metal studs on both sides (t=0.012m). Scenario 2 compares a baseline gypsum cardboard wall with metal stud-double plasterboard on one side (t=0.019m) with P1 Geberit GIS. The third scenario compares the previous baseline version against P1 Geberit GIS, P5 Systimber and P2 Saint-Gobain Group.

Scenario 1 - Interior wall - Yearly transformations (Figure 97)

- higher initial financial costs for all reversible interior wall solutions compared to the baseline interior wall
- return on investment is already achieved after the first transformation (i.e. after one year) for both reversible wall solutions.
- lower refurbishment costs and deconstruction/reassembly costs, with best score for Systimber

Scenario 2 - Technical interior wall - Transformations every 10 years (Figure 98)

- higher initial financial costs for all reversible interior wall solutions compared to the baseline interior wall
- after the second transformation, the reversible wall solution has a better (life cycle) financial performance
- design characteristics of the reversible solution and direct reuse of the wooden panel

Scenario 3 - Partition wall - Transformations every 15 years (Figure 99)

- Saint-Gobain solution has a lower initial financial cost than the Baseline wall, due to low material and installation costs,
- Geberit GIS remains the most expensive element. There is no financial incentive to consider this reversible wall solution for home-use, but rather for spaces with higher transformation rates.
- Systimber is already competitive after year 5
- the Saint-Gobain Group has a lower initial cost and lower life-cycle costs.

“Although stakeholders sponsored many of the applied materials in the CRL project, building in a reversible manner leads to a higher initial investment cost. Life cycle costing shows that these costs can be recuperated when considering transformations during the lifetime of the project or building system. This is however only cost-efficient on the longer term.” CRL Team

Figure 97: Scenario 1, LCC assessment of three interior wall systems (Geberit and Systimber) compared to a conventional non-reversible wall in case of implementation in a partition wall. (early transformations)

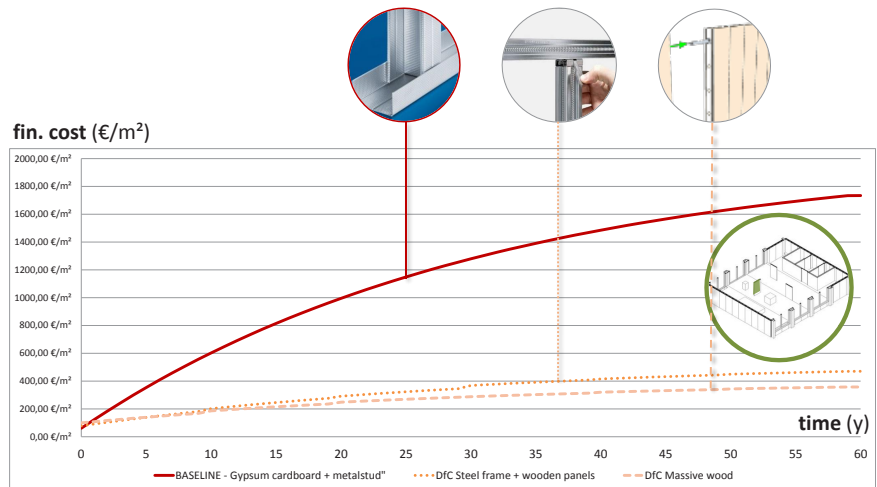

Figure 98: Scenario 2, LCC assessment of the Geberit GIS system compared to a conventional non-reversible wall in case of implementation in a technical wall. (Transformations every 10 years)

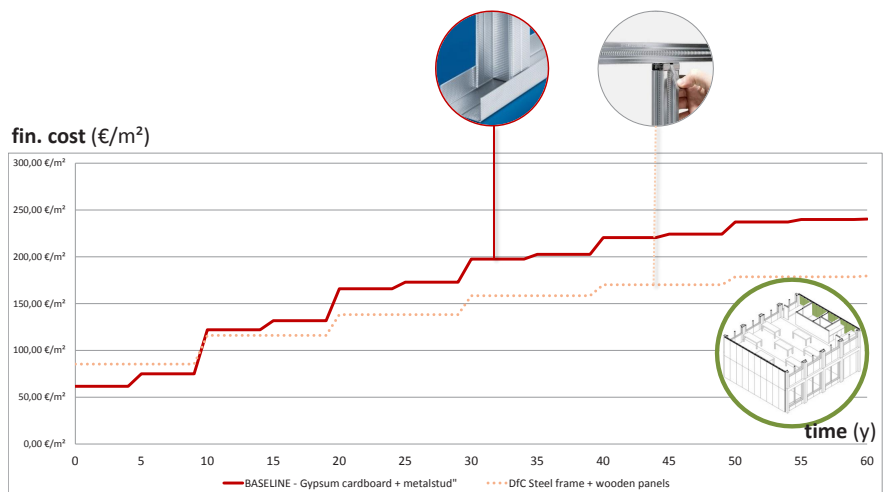
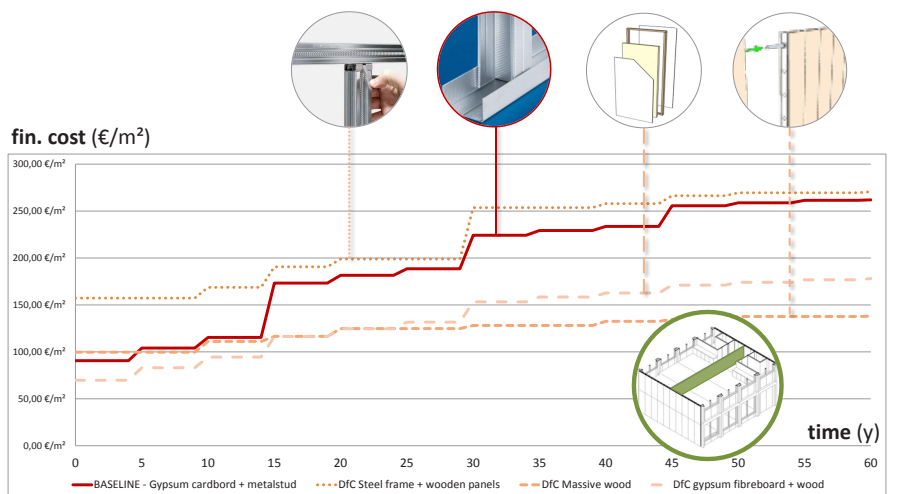

Figure 99: Scenario 3, LCC assessment of three interior wall systems (Geberit GIS, Saint-Gobain type 1 and Systimber) compared to a conventional non-reversible wall in case of implementation in a partition wall. (Transformations every 15 years)



ARE YOU READY TO COLLABORATE?

8. STAKEHOLDER ECOSYSTEM



"IT IS FAIR TO SAY THAT A CIRCULAR AND REVERSIBLE BUILT ENVIRONMENT CAN ONLY BE SUPPORTED BY A HIGHLY INTERCONNECTED VALUE NETWORK. BECAUSE OF THE MAGNITUDE OF INFORMATION AND VARIETY OF STAKEHOLDERS WITHIN THE BUILDING VALUE NETWORK, A DIGITAL WAY OF COLLECTING, HANDLING AND EXCHANGING DATA SEEMS INDISPENSABLE." © BAMB

8.1. WHAT WE LEARNED FROM PROTOTYPING

The pilot project building process highlighted that the development of circular solutions requires working within the 'ecosystem' of stakeholders. It showed the importance of integrating downstream value chain contributors in the up-front conceptual phase. Moreover, it confirms the interest of some stakeholders to extend their role beyond their primary activities.

If materials and systems should be reused and continuously improved, if ownership paradigms change, if co-creative ways of developing products are actively integrated in value networks and if sharing economy model scales up, different partnerships and relationships are required to ensure a sustainable transition from a product to a service business model.

Several aspects were identified through the feasibility study (D12) and confirmed during the prototyping process (D13) and the construction phase:

1. The stakeholder ecosystems of the pilot projects can be considered a decentralised network. Stakeholders operate within **a value network rather than along a classical linear value chain.**
2. All stakeholders are actively involved in the various construction phases. Going beyond the traditional one life-cycle (design and build), their involvement is also required in the building exploitation phase, redesigning, and so on. From the the start, there is a need to **co-create future transformations** together.
3. The construction industry is interested in testing new models. Looking forward to keep pace with **new technologies, societal change, and customer needs**, more and more companies are participating in new product development.
4. A new role of **coordination** is necessary to articulate different actions and interventions, and to integrate circularity concepts upfront. This role can be taken on by a stakeholder, but also through a platform, a software able to integrate data and provide information tailored to the needs of each stakeholder.

8.2. WHAT WE LEARNED FROM THE BUILDING PHASE

The circular economy requires a paradigm shift. This means: a change in all activities, the reorganisation of the stakeholder 'ecosystems' and associated roles, in terms of responsibility, risk and profitability.

Although these perspectives bring uncertainty and consequently fear of change, at this incipient transition stage, involvement of every contributor in the current value chain is important. In order to enable the shift to circular economy, everybody has to align with the overarching environmental objectives, investigate and test the actions that will allow the emergence of new 'ecosystems' able to create new win-win situations.

8.2.1. VALUE NETWORK

To transform a traditional "value chain" into a "value network" gathering stakeholders is easy within a pilot project when stakeholders are already convinced and committed. To scale up this experience, in a real day-to-day context is definitely a challenge. Especially in large-scale projects where activities tend to be organised in silos and thinking in a collaborative way demands stakeholders to step out of their "comfort zone".

In large-scale project, the governance at different levels (industry, companies managing the project, regulation) are often complex and rigid. Potential barriers are related to the contractual dependencies and the lack of direct relations between the stakeholders such as the owner and the contractor.

Lack of communication between stakeholders, lack of common language, and lack of common standards are often neglected barriers with high impact.

In a short-term financial perspective, the investment needed upfront to develop a reversible solution can be seen as a burden. Additional budget is needed for earlier interaction and collaboration, meetings, search for partnerships, and research.

8.2.2. CO-CREATION

In the pilot-projects, stakeholders became aware of the necessary changes in project governance and their extended involvement.

For example, in a circular economy context, the traditional mission and responsibility of an architect would be extended to include the operating, transforming, and disassembly stage. In the same way, in an effective circular building, product suppliers might need to extend their activities to include later stages (e.g. maintenance, take-back...).

The CRL involved contractors, manufacturers, designers, and researchers upstream, in an intensive collaborative design process with very good circular results.

Once the construction has started, more and more manufacturers and construction contractors from small to big companies became interested in the “reuse” potential of materials. Digitalisation is raising a lot of interest as well as expectations.

Industry is looking for results. The fact that extra economic value related to materials and products can be created and captured throughout several transformations is an incentive.

Manufacturers are keen to test the improvement of their existing products. The GTB Lab module and the CRL involved well known industrial stakeholders that re-designed the connection of their systems to become circular.

The BRIC project brought together an ecosystem of “stakeholders” motivated to reduce waste and to seize the opportunities of supply chains of reused materials. Within a traditional framework, there is no reuse of materials. Within the circular economy, new roles and activities related to the supply of reused materials are emerging. Pilot project stakeholders realised the importance of continuously extracting information about the materials used by the pilot project.

This tremendous change implies changes in the way responsibilities are shared and represents one of the main barriers to a systemic shift. The difficulty stands in assessing the risk associated to the change, align policies and standards to circular economy needs.

8.2.3. COORDINATION

Who is going to coordinate the circular construction implementation? There is no consensus regarding this question. Currently, all stakeholder have a rather self-centred perspective. Below, some insights from the pilots’ development are provided:

- Architects seemed to be the most convinced, they already promote circularity, but their decision making power is not strong enough to drive the changes,
- The manufacturers are looking forward to the opportunities that will be generated by digital disruption; due to their market position, they are likely to play an important role.
- There is a need to involve project developers and contractors even more: they often make decisions on criteria at the final procurement stage.
- Financial institutions, policymakers, and digital players should actively participate in the process and continue to investigate new ways to enable and support this shift.

Digital platforms, BIM models, and concepts such as structured data (chronological block-chain information) are increasingly considered key tools, so are coordination spaces that offer infrastructure for collaboration. A question arises: are digital players holding the key to collaboration?

8.3. NEXT STEP: EXTENDED NETWORK, CLOSE THE LOOP

A successful value proposal and business model resides in a wider web.

BAMB pilots successfully brought together resources and activities, partners, advisers, suppliers, service providers, distribution and logistics.

Learning from these pilots, the next step will be binding together a valuable ‘ecosystem’ integrating two specific aspects:

USER NETWORK

Integrating and empowering users is likely to be key. A more socially inclusive circular economy would both focus on environmental aspects and user’s needs. Circular solutions should include and address segments of the population, such millennials, disfavored segments for whom building products are not offering proper solutions today.

NEW FORMS OF INTERNAL ORGANISATION Horizontal organisation/ self-steering organisation are likely to reshape the whole organisational and industry ecosystem.

BRIC

Some 180 students (carpenters, plumbers and heating installers, garden contractors) participated in the BRIC construction project. BRIC can be considered a true laboratory of knowledge. The impact of the project and the opportunity to disseminate knowledge are very high. After the training, students are back on the work site and can apply directly the circular construction principles.

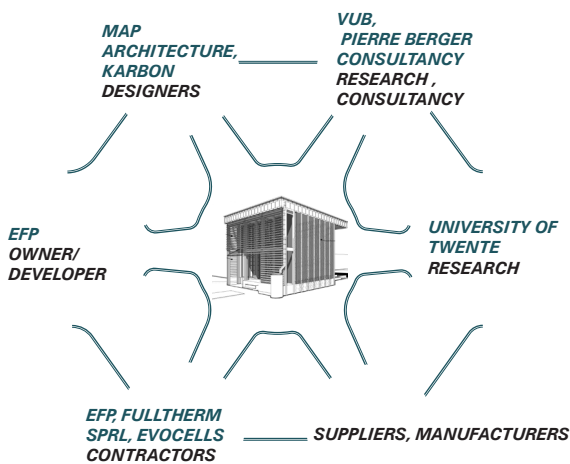
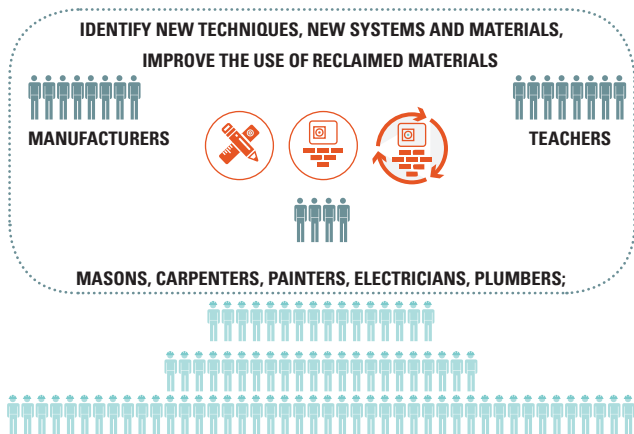

Figure 100: Extended BRIC network

GTBL

ODS Kloeckner, a member of the Janssen group, agreed to develop a reversible and multifunctional new steel profile with fitting connections that can be used, to be applied within the GTB Lab. ODS Kloeckner has supported the process by providing know-how about the engineering and production of steel profiles as well as the production of the pilote project.

Once the principles and solutions have been defined each industry partner was responsible for the development and assembly/ disassembly of their own system. Architect has created a BIM model which has been communicated with all industry partners based on which the production drawings have been generated. Steel structure formed the base for the process and production preparation. Steel structure has detement details and dimensions of all other compon-

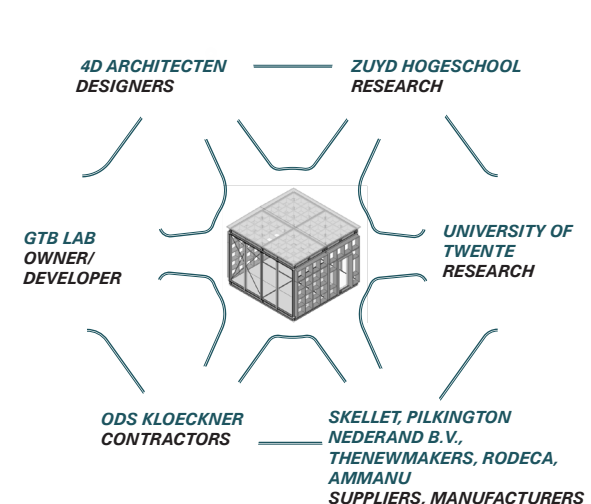

Figure 101: Extended GTBL network

REMs

During several meetings, the design team (&Lotte), the client (EPEA) and the constructor (Gielissen) of the REMs have been discussing the design optimisation and the cost efficiency. During these sessions, several adjustments were made to the design to ensure the reversibility and improvement of the pilot.

In a broader perspective, all the manufacturers of the seventy products displayed in the REMs exhibition became active stakeholders. They were able to give feedback and to participate in the development of the Material Passports platform. Visitors of the exhibition gave meaningful insights about the passports and the interaction between the physical product and the digital platform.

CRL

Collaborating with industrial partners in this project showed how dependent the development of circular architecture is on innovations in the construction sector and more specifically building system manufacturing. Further expanding the range of reversible building systems will lead to an increased design freedom. In this case, questions of standardization and interchangeability become even more important.

The projects integrated different circular solutions for facade systems, technical services, floor, ceiling and partition walls developed by different producers. Managing producers, designers, experts, and contractors requires a new role of coordinator or facilitator who is able to conduct the activities of the ecosystem and extract the maximum value, creating win-win situations for different actors and users.

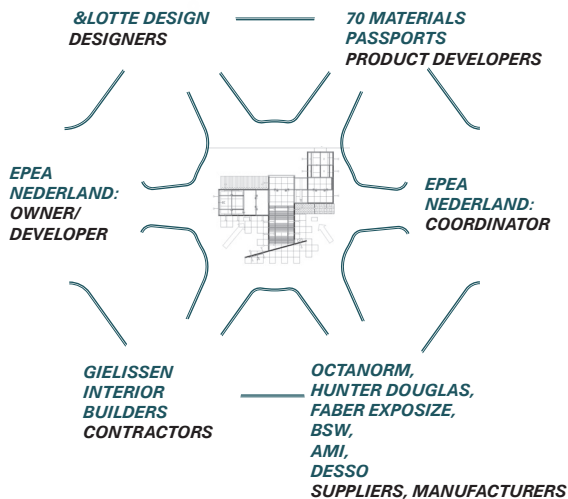

Figure 102: Extended REMs network

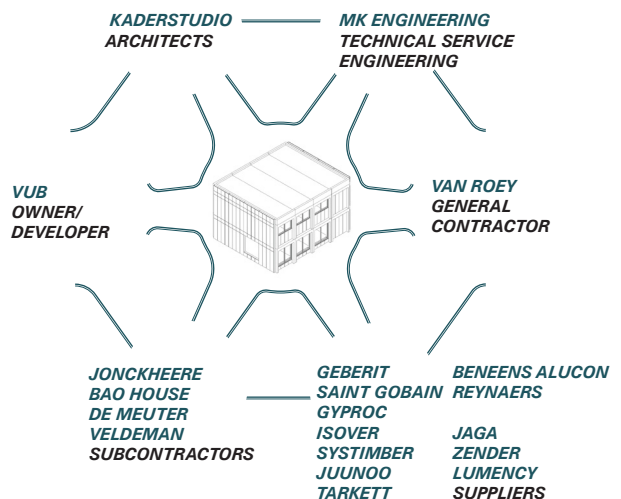

Figure 103: Extended CRL network

ARE YOU PREPARED FOR CIRCULAR POLICIES ?

9. POLICIES AND STANDARDS



"ENVIRONMENT, JOBS, CLIMATE CHANGE AND RESOURCE SECURITY ARE SOME OF THE OFTEN QUOTED INCENTIVES FOR AUTHORITIES TO STRIVE FOR A CIRCULAR ECONOMY. GOVERNMENTS ON DIFFERENT LEVELS CAN CREATE PRECONDITIONS FOR A CIRCULAR BUILDING SECTOR THROUGH DIFFERENT INCENTIVES, POLICIES, STANDARDS AND REGULATIONS." © BAMB

9.1. LEARNING FROM THE PILOTS

Shifting towards a circular building environment requires operational regulations to transform circular visions into tangible projects. The “Buildings as Material Banks” partners have identified measures that will boost transition from a linear approach to sustainable, closed loops construction processes. Insights from the pilot projects have enriched the thinking on how policies can be shaped to scale up successful circular building models.

Policies should support the transition process and be designed within a strategy of change, sensitive to impacts and risks.

ACCESSIBILITY

Public measures should support high quality and inclusive use of the existing building stock and its efficient and long term utilisation. Restrictive regulations should become opportunities for developing innovative ways of sharing, and transforming spaces according to the user’s needs.

CLEAR TARGETS FOR CIRCULARITY

Clear circular economy targets and measures such as reversible design, flexible buildings, and materials passports should be defined.

SYNERGIES BETWEEN DISCIPLINES

The implementation of these measures should create synergies with existing regulations and experience related to health and the environment, waste management, energy transition and performance, water management, mobility, food policies, building regulation, material quality standards, etc. Buildings are part of systems. Achieving full building circularity depends on a holistic integration of these aspects.

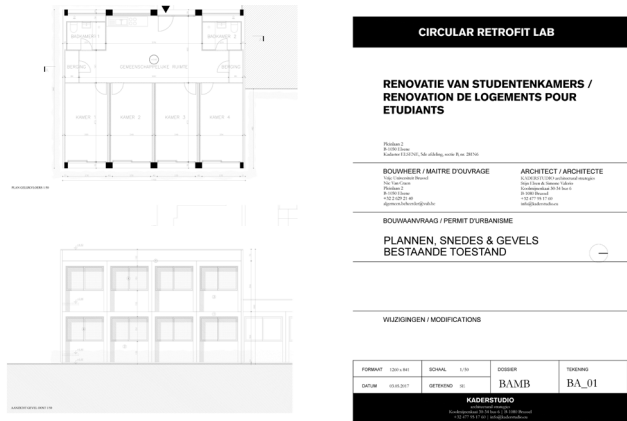
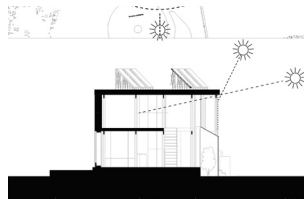

Figure 104: CRL permit procedure

CIRCULAR RETROFIT LAB

The urban planning permission process required for the renovation of the Circular Retrofit lab is ill-adapted to the functional flexibility promoted by the project. Within the current procedure, only one function can be attributed to a building. The future transformation has to be accompanied by a new tedious procedure.

CBATool: Circular Building Assessment is an assessment approach and method developed within BAMB by partners. It aims to provide a holistic evaluation and interpretation of **multiple sustainability aspects of buildings and their parts**. See *BAMB website* and Page 98 illustrating how the environmental aspect of the methodology was tested on BRIC.

BRIC 1 WATER MANAGEMENT AT THE LEVEL OF THE PARCEL

Concerned about excessive use and shortage of water resources in the urban environment, the BRIC project embraces a closed-loop solution for water management. The project uses a composting waterless toilet. Grey water is treated on-site by a planted gravel filter.

BRIC2 AS A PRODUCTIVE BUILDING

BRIC2 is reusing BRIC1 solutions for water treatment and energy production. Moreover, the greenhouse situated on the south façade of the building will produce hop. The crop will be used in the training program for future brewers.

SYNERGIES BETWEEN SCALES

ENABLE INTEGRATION OF EXTERNAL COSTS

Coordination between scales, from European through Regional to city scale, local community and building scale, will reduce inconsistencies and increase the effectiveness of future circular policies (see Figure 105). Design policies taking a broader territorial perspective will allow the integration of environmental costs in the building project.

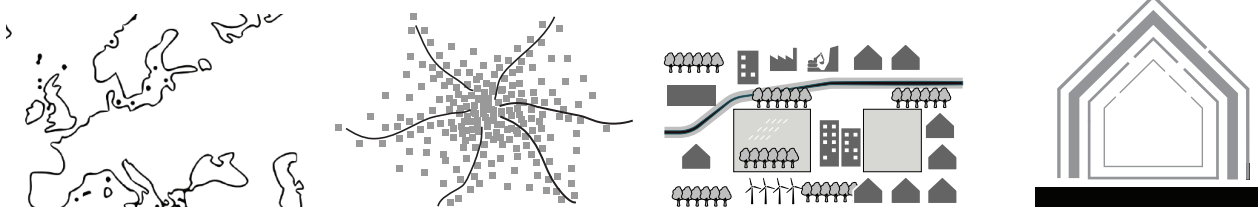

Figure 105: From European to city, neighbourhood (community) and building level

ENVIRONMENTAL COSTS The inclusion of real costs is likely to boost the circular transition. However, implementation strategies are required to cope sustainably with potential short-term social costs (e.g., step-by-step implementation).

The integration of environmental costs should be coordinated with policies and quality standards regarding Building Reversible Design, as well as materials and their re-use potential.

THE CIRCULAR RETROFIT LAB :

Although the Brussels Region has adopted a circular economy strategy for the building sector, at the local district level, the building permit procedure is still static and not coordinated with the regional vision, yet. Changes in the procedure have a broad impact. They imply a change of the professional status of architects, redefinition of their mission, its liabilities related to the project and its future transformations, building compliance, etc.

BRIC 1 ENVIRONMENTAL COSTS :

BRIC was subject to different calculations, done by various partners. The Brussels Environment’s TOTEM (Tool to Optimise the Total Environmental impact of Materials) is not strictly a circular tool, yet, but it presents the advantage to “evaluate the environmental impact of building materials or buildings” within the Belgian market context. Environmental effects of materials along the construction value chain (from construction to disposal) are monetised as a building cost (€).

SYNERGIES BETWEEN STAKEHOLDERS

Incentive schemes are necessary to foster innovative collaboration between broad stakeholders groups that can create more value for the buildings and users. Stakeholders should be able to capture the value generated and share the risk accordingly.

THE CIRCULAR RETROFIT LAB :

The “architecture” of the pilot project developed by the VUB (Vrije Universiteit Brussels) allowed a fruitful collaboration between key stakeholders of the supply and value chains. It highlighted the power of co-production between architects material suppliers, coordinators, etc. However in real day-to-day practice, the procurement system hinders such collaboration.

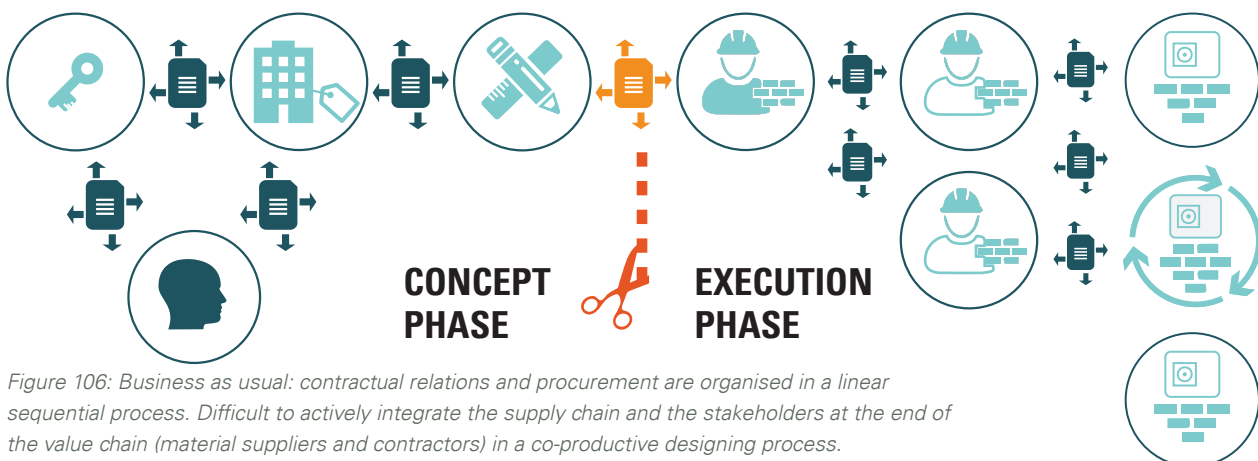

Figure 106: Business as usual: contractual relations and procurement are organised in a linear sequential process. Difficult to actively integrate the supply chain and the stakeholders at the end of the value chain (material suppliers and contractors) in a co-productive designing process.

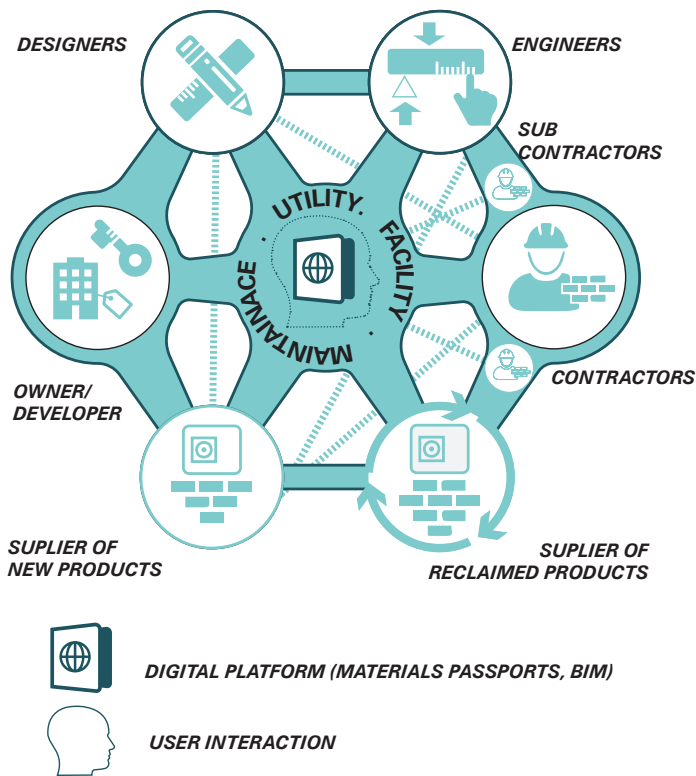

Figure 107: A value network enabled by digital tools

POLICY AS PROCESS FACILITATOR

Policies need to focus on facilitating necessary circular implementation processes. To reduce and prevent barriers, policymakers have to actively involve stakeholders and social partners during policy design.



CRL experienced several setbacks related to the current policies and standards.

1. Building permits do not allow future transformations. Each functional transformation requires new procedures.
2. Several circular walls developed by the team could not be implemented. Fire tests involve additional delays and high costs. Producers are only ready to pay when the building product is ready for market uptake.
3. The ten-year legal responsibility for buildings applies to certain stakeholders. Architects and contractors are not keen to implement innovative solutions which are not market proven and thus riskier.
4. The rigidity of building codes impedes suppliers to develop innovative leasing models for their products.

POLICIES AS INCLUSIVE TOOLS

Coordination between the public and private sectors is essential. Circular tools should be developed not only for use within the building industry, but by users, clients, third-party stakeholders, who should be able to integrate and make use of them simply and conveniently.

COMMON LANGUAGE, COMMON TOOLS

The collaboration of GTB Lab, CRL, BRIC, BAMB projects' stakeholders and partners was enabled by the use of BIM Models. However, in real life, not all stakeholders have the knowledge and access to these tools. Policies should support the development of common platforms.

DATA

The amount of data can easily be overwhelming. Data required should not only be reliable but organised according to the user's needs. The convenience in using data should be a priority.

Through the development of REMs, and the Materials Passports platform, the team gather feedback for industry stakeholders. Data efficiency, customisation are key points in providing valuable information about the materials.

9.2. BEYOND THE CONSTRUCTION INDUSTRY

The Buildings as Material Banks project highlights that a transition towards a circular economy necessitates a systemic shift. Therefore, revising policies in related industries is key, notably concerning:

- Insurance sector,
- Finance and taxation,
- Accounting standards,
- Corporate law to enable new types of business entities allowing innovative processes across organisations and stimulating long-term perspectives for owners and shareholders,
- Data sharing,
- Digital industry and the role of big players on the market .

Experience from other industries shows that this transition is likely to open up the debate on sensitive issues such as property rights, collaborative processes, “big data”, data exchange, privacy and so on. For example, today, these aspects are considered subject to controversy in the transport sector and a barrier for the mobility sustainable development.

9.3. CIRCULAR MIND-SET

Through policies, public bodies should support transition by ensuring continuous access to information, education, and training and the involvement of the society in the circular process.

As explained previously, a circular economy involves a value network of multi-disciplinary and multi-industry stakeholders. These need to share a common understanding, and public authorities need to create bridges and increase communication between sectors.

Alignment of different levels of public decision making is one of the keys to a successful circular transition.

As previously mentioned, the urban planning permission process required for the renovation of the Circular Retrofit Lab was not adapted to the project’s circularity. Although the Brussels Region has adopted a circular economy strategy, at the municipal level, the procedure is still static and not coordinated with the regional one.

Procurement processes and contractual relationships should integrate risk sharing to enable collaborative and co-production-based building processes. The pilot projects provide evidence of the current practices, but also the emergence of new societal models, related to use, businesses, operations and so on.

Circular solutions should not only address sustainability-goals. To achieve their environmental objective, they should address people’s needs. Through a collaborative process, they should create and capture value for the various stakeholders along the value chain.

10. ENDNOTES

1 Activities refer to the primary and support activities such as defined by Michael Porter's value chain model

2 BAMB reversible design tools are developed by U-Twente

3 The word "layer" refers to Stewart Brand's theory of seeing a building as a set of 'shearing' of layers, as well as at the extended methodology about reversible design developed by Elma Durmisevic

4 The CBA tool and platform was developed by BRE and Sundahus. Vito supported in the Environmental Method development

5 Sources: COM (2011) 57, COM (2007) 860, COM (2007) 414, European Commission (DG ENV) - SERVICE CONTRACT ON MANAGEMENT OF CONSTRUCTION AND DEMOLITION WASTE – SR1 Final Report Task 2, February 2011

6 Herzog, 2012.

7 EN 15978:2011. Sustainability of construction works. Assessment of environmental performance of buildings. Calculation method. 201

8 BRE Global Ltd. BRE Global Methodology For The Environmental Assessment Of Building Using EN 15978:2011. PN 326 Rev 0.0. 1st January 2018.

9 Simapro. Available from: www.simapro.co.uk/ Accessed 14 December 2018

10 www.greenbooklive.com/filelibrary/EN_15804/PN514-BRE-EN-15804-PCR.pdf

11 The Brussels Environment's TOTEM (Tool to Optimise the Total Environmental impact of Materials) "evaluate the environmental impact of building materials or buildings" within the Belgian market context. Environmental effects of materials from construction to disposal are monetised as a building cost (€).

11. BIBLIOGRAPHY

Albrechts, Louis. 'Reframing Strategic Spatial Planning by Using a Coproduction Perspective'. *Planning Theory*, vol. 12, no. 1, Feb. 2013, pp. 46–63. *plt.sagepub.com*, doi:10.1177/1473095212452722.

BRE Global Ltd. *BRE Global Methodology For The Environmental Assessment Of Building Using EN 15978:2011*. PN 326 Rev 0.0. 1st January 2018.

Circular Economy and Design for Change within the Built Environment: Preparing the Transition. 2017. <http://resolver.tudelft.nl/uuid:3f5ef013-fcef-499f-896e-2e4828526e4e>.

Design Support for Revisable Buildings with Focus on Visualizing and Simulating Transformation Capacity during Initial Design Phase. 2017. <http://resolver.tudelft.nl/uuid:06db3f64-095d-4000-ba2e-60fa3a24df28>.

Durmisevic Elma. *Transformable Building Structures. Design for Dissassembly as a Way to Introduce Sustainable Engineering to Building Design & Construction*. [s.n.], 2006.

Ellen MacArthur Foundation. *Growth within: A Circular Economy Vision for a Competitive Europe*. Ellen MacArthur Foundation Publishing, 2015.

Ferber, Stefan. 'How the Internet of Things Changes Everything'. *Harvard Business Review*, 7 May 2013, <https://hbr.org/2013/05/how-the-internet-of-things-cha>.

Herzog, Thomas. *Construire en bois*. Presses Polytechniques et Universitaires Romandes, 2012.

How Do Current Policies Support a Transition towards a Circular Economy in the Built Environment? 2017. <http://resolver.tudelft.nl/uuid:1ed15852-4a93-4d5a-b1c0-409c8b74a1bc>.

Jelassi, Tawfik, et al. *Strategies for E-Business: Creating*

- Value through Electronic and Mobile Commerce ; Concept and Cases*. Pearson, 2014.
- Luscuere, Lars Marten. 'Materials Passports: Optimising Value Recovery from Materials'. *Proceedings of the Institution of Civil Engineers - Waste and Resource Management Proceedings of the Institution of Civil Engineers - Waste and Resource Management*, vol. 170, no. 1, 2017, pp. 25–28.
- Meek, Andy. 'What Role Should the Government Play in Developing the Internet of Things?' *The Guardian*, 14 Oct. 2015. *The Guardian*, <http://www.theguardian.com/technology/2015/oct/14/government-regulation-internet-of-things>.
- NIBE *Milieuclassificatie Bouwproducten*. <https://www.nibe.info/nl>. Accessed 26 Feb. 2019.
- Porter, Michael E. *Competitive Strategy: Techniques for Analyzing Industries and Competitors*. Free Press, 2014. <http://www.myilibrary.com?id=894079>.
- Porter, Michael, and James Heppelmann. *Managing the Internet of Things: How Smart, Connected Products Are Changing the Competitive Landscape*. 2014. <http://proquest.safaribooksonline.com/?fpi=3917941900001>.
- The Circular Economy Moving from Theory to Practice*. Pdf. <https://www.mckinsey.com/~media/mckinsey/business%20functions/sustainability%20and%20resource%20productivity/our%20insights/the%20circular%20economy%20moving%20from%20theory%20to%20practice/the%20circular%20economy%20moving%20from%20theory%20to%20practice.ashx>. Accessed 15 Nov. 2019.
- The Internet of Things Is Revolutionising Our Lives, but Standards Are a Must | Media Network | The Guardian*. <http://www.theguardian.com/media-network/2015/mar/31/the-internet-of-things-is-revolutionising-our-lives-but-standards-are-a-must>. Accessed 29 Feb. 2016.
- The-Circular-Economy-Opportunity-for-Urban-Industrial-Innovation-in-China_19-9-18_1*. Pdf. https://www.ellenmacarthurfoundation.org/assets/downloads/The-circular-economy-opportunity-for-urban-industrial-innovation-in-China_19-9-18_1.pdf. Accessed 26 Feb. 2019.
- 'Totem: A New Tool to Improve the Environmental Performance of Buildings'. *EnergyVille*, <https://www.energyville.be/en/news-events/totem-new-tool-improve-environmental-performance-buildings>. Accessed 26 Feb. 2019.
- 'VERBORGENE WERTE'. *modulart*, 21 June 2017, <https://modulart.ch/verborgene-werte/>.
- Viganò, Paola. *Territorialism*. Harvard University Graduate School of design, Fall 2012.
- Wirtz, Bernd W., et al. 'Strategic Development of Business Models: Implications of the Web 2.0 for Creating Value on the Internet'. *LRP Long Range Planning*, vol. 43, no. 2, 2010, pp. 272–90.

LIST OF FIGURES

CREDITS ILLUSTRATION/ CONTENT

1. BUILDINGS AS MATERIAL BANKS

Figure 1: Towards a circular construction ecosystem
Buildings as Material Banks Horizon2020 Innovation project

Figure 2: Articulation of the pilots projects around the Buildings as Material Banks Horizon2020 Innovation project's major topics

Figure 3: A new life-cycle approach in the construction industry, enabled by BAMB tools

Figure 4: In a circular economy, the user's needs and consciousness about environmental challenges are key for a successful transition

Figure 5: Integration of the broader societal challenges and of environmental cost and impact into the circular reflection

2. REPORT SUMMARY

Figure 6: Overview of the pilot projects and BAMB work package 4 (WP4) actions

Figure 7: Testing BAMB Results Through Pilot Projects

3. GENERAL PRESENTATION OF PILOT PROJECTS

Figure 8: Location of the pilot projects

4. ASSESSMENT OF CONSTRUCTION, DISASSEMBLY, TRANSFORMATION AND RELOCATION

Figure 9: Overview of the construction sector environmental impact

Figure 10: Medium growth scenarios of the world population growth expectation , source: <https://www.oecd.org/>

Figure 11: High quality urban structures, (public spaces, and landscapes), sustainable mobility and energy strategies, etc., create conditions for valuable, sustainable and circular buildings. A

Figure 12: Circular design integrates early reflections on all building stages

Figure 13: Building reconfiguration

Figure 14: Spatial reversibility

Figure 15: Technical Reversibility Components, Elements And Building Level, Durmisevic model, U-Twente

Figure 16: Types of materials used in the BAMB pilot projects

Figure 18: Adaptation from Elma Durmisevic the Hierarchical structure of knowledge model available from Reversible Building Design Framework 3

Figure 19: Stewart Brand's 'Shearing Layers' of a building

Figure 20: Projet BRIC 2, axonometric views (insulation boxes and finishing), groundfloor plan and second floor plan

Figure 21: BRIC 1, facades

Figure 22: BRIC 1 plans

Figure 23: Inventories and reuse strategy for BRIC 2

Figure 24: Splice joint

Figure 25: Mortise and tenon joint

Figure 26: Connection of the roof structure

Figure 27: The columns were constructed during the EFP workshop in the winter 2018

Figure 28: Columns and the circular features

Figure 29: Cross lap joint

Figure 30: Screwable pile with connections

Figure 31: Insulated timber wall construction

Figure 32: Insulated cassette

Figure 33: Timber wall construction

Figure 34: The insulated cassettes for the facade system were realised in the EFP workshop during the winter 2018

Figure 35: Transformation for the rockpanels

Figure 37: BRIC 1

Figure 38: BRIC 2

Figure 39: Improvements BRIC2

Figure 40: BRIC2 Model

Figure 41: Overview of first stage of GTB Lab module

Figure 42: Floor plan and section of the transformation of GTB Lab module

Figure 43: Overview of assembly sequences of GTB Lab Module

Figure 44: Overview of the transformation sequences of GTB Lab Module

Figure 45: Prototyping phase

Figure 46: source Metsawood

Figure 47: Overview of reversible GTB Lab module system composition

Figure 48: From single glazing to triple glazing, GTB Lab

Figure 49: Overview of reversible GTB Lab module system composition

Figure 50: REMs initial plans

Figure 51: Plans of the exhibition setup for Ecobuilt

Figure 52: Plans of the exhibition setup for Dutch Design Week

Figure 53: The hooks on the panels in the form of screwed Z-profiles use the already integrated slots in the Octanorm profiles (left).

Figure 54: Gielissen developed corner panels to create a smooth finishing whilst keeping the standardized panel dimensions

Figure 55: The Armstrong ceiling combined with the wooden NON ignis ceiling panels was installed in the office unit from Ecobuilt onwards. The canopy construction also allows for side lighting.

Figure 56: Research by design, identification of the scenarios	VUB
Figure 57: Subsequential functional transformation	VUB
Figure 58: Internal, external transformation and reconfiguration	VUB
Figure 59: Original composition	VUB
Figure 60: Original plan of a cluster of 4 modules, containing 4 student rooms, 2 bathrooms, 2 storages spaces, a kitchen and common space	VUB
Figure 61: First renovation phase	VUB
Figure 62: Transformation phase	VUB
Figure 63: Existing circular capacity,	VUB
Figure 64: Variel system	BE/VARIEL
Figure 65: Existing flexibility	BE/VUB
Figure 66: The urban potential and horizontal expandability of the Variel© modules	BE
Figure 67: Efficient organisation of the space and technical services.	VUB
Figure 68: Wall transformation strategy	VUB
Figure 69: First floor, first and second phase	VUB
Figure 70: Insert method	BE
Figure 71: Facades CRL, Precision for future components exchange	VUB
Figure 72: Schemes based on the technical details provided by the CRL team	BE/VUB
Figure 73: Transforming Lab	VUB
Figure 74: Transformation of the test lab after the first workshop to the development of the event space in the second workshop.	VUB
Figure 75: Transforming Lab during the tests	VUB

5. DATA SHARING THROUGH MATERIALS PASSPORTS DEVELOPMENT

Figure 76: A Materials Passports Platform concept, based on the VUB team reflections	BE/VUB
Figure 77: Material Passports developed by EFP centre for the BRIC project	efp
Figure 78: Material inventory used by Karbon Architects for the BRIC project	Karbon&efp

6. CIRCULAR LIFE CYCLE ASSESSMENTS

Figure 79: BRIC study period concept (KARBON Architecture).	BRE (images Karbon)
Figure 80: System boundary concept.	idem
Figure 81: Circular Design Schedule	BRE
Figure 82: Circular Design Measures	BRE
Figure 83: Non Circular Design Measures	BRE
Figure 84: Cumulative Impact over time of BRIC Circular Design vs BRIC Non-Circular Design	BRE (images Karbon)
Figure 85: Climate change impact (100 yrs) for extreme scenario, 1 transf. every 7 yrs	VITO
Figure 86: Climate change impact (100 yrs) for realistic scenario 1 transf. every 10 yrs	VITO

Figure 87: Climate change impact (100 yrs) for conservative scenario 1 transf. every 20yrs	VITO
Figure 88: Environmental impacts per m ² , yearly transformation	VITO
Figure 89: Environmental impact per m ² Decennial transformation	VITO
Figure 90: Environmental impact per m ² transformation every 15yrs	VITO
Figure 91: Disassembly of BRIC 1; (photo Karbon)	Karbon

7. BUSINESS MODELS

Figure 92: A scenario for industry transformation	Illustration BE
Figure 93: Four-factor model Web 2.0 developed by B. Wirtz et al.	
Figure 94: DIGITAL TRANSFORMATION Adaptation of concepts after Jelassi and Porter 2014 and 2015	Illustration BE/ Jelassi Porter
Figure 95: ODS worked together with GTB Lab to test the Reversible Building Design	4D
Figure 96: Scenario 1, LCC assessment of three interior wall systems (Geberit and Systimber) compared to a conventional non-reversible wall in case of implementation in a partition wall.	VITO
Figure 97: Scenario 2, LCC assessment of the Geberit GIS system compared to a conventional non-reversible wall in case of implementation in a technical wall.	VITO
Figure 98: Scenario 3, LCC assessment of three interior wall systems (Geberit GIS, Saint-Gobain type 1 and Systimber) compared to a conventional non-reversible wall in case of implementation in a partition wall.	VITO

8. STAKEHOLDER ECOSYSTEM

Figure 99: Extended BRIC network	BE/efp
Figure 100: Extended GTBL network	BE/SGDF
Figure 101: Extended REMs network	BE/EPEA
Figure 102: Extended CRL network	BE/VUB

9. POLICIES AND STANDARDS

Figure 103: CRL permit procedure	VUB
Figure 104: From European to city, neighbourhood (community) and building level	BE
Figure 105: Business as usual: contractual relations and procurement are organised in a linear sequential process. Difficult to actively integrate the supply chain and the stakeholders at the end of the value chain (material suppliers and contractors) in a co-productive designing process.	BE
Figure 106: A value network enabled by digital tools	BE

10. ENDNOTES

11. BIBLIOGRAPHY

